



MADE IN ITALY

HR / EN

MADE
IN
ITALY



ITALIAN
PRODUCTION



MADE FOR YOU

MI PROIZVODIMO U ITALIJI

Mi proizvodimo u Italiji.

Strategija naše tvrtke zasniva se na vrijednostima talijanske kulture, koja je osnovna za proizvodni proces i marketing: talijanska proizvodnja, prilagođavajući proizvod, strast za istraživanjem i kreativnost su glavne smjernice za razvijanje savršenog proizvoda za svakog kupca.

WE ARE MADE IN ITALY

We are made in Italy.

The company strategy is based on the values of the Italian culture, which is recalled on the production process and marketing choices: Italian production, product customization, passion for research and creativity are the main guidelines to develop the perfect product for each customer.

VJERUJEMO U NAŠU ZEMLJU

Proizvodimo u 3 naša talijanska pogona u Romano d'Ezzelino, Pove del Grappa i Cassola. Prema našim kriterijima, kvaliteta je osnova svega: zadržavajući i dalje naš know-how u Italiji, naša je tajna formula. Zasluge za to idu obitelji Alban koja je odlučila da zadrži čvrste veze sa lokalnom zajednicom u cilju očuvanja općeg blagostanja i stabilnosti iste.

WE BELIEVE IN OUR COUNTRY

We produce in our 3 Italian plants in Romano d'Ezzelino, Pove del Grappa and Cassola. For us, quality is in pole position: keeping our know-how in Italy is our secret formula.

The choice came by the Alban family decision to hold tight their ties with the local community in order to preserve its wellbeing and stability.

DIZAJNIRAMO SOLUCIJE ZA VAS

Znanje na svjetskom tržištu, kvalificirani proizvodni menadžeri za sve proizvodne programe, talijanska proizvodnja kontrolirana korak po korak, AGB Laboratorij za istraživanje i razvoj: to su strateški izbori koji nam omogućavaju da ponudimo kupcima personalizirana rješenja. To je proizvodnja napravljena za Vas, posvećena Vama.

WE DESIGN THE SOLUTION FOR YOU

Knowledge of the International market, qualified product managers for each product range, Italian production controlled step by step, AGBLab Research & Development laboratory: these are the strategic choices which allow us to offer personalized solutions for the customer. It is a production Made for you, dedicated to you.



CREATIVITY AND INNOVATION



PARTNERSHIP



DESIGN

STALNO INVESTIRAMO U NOVE IDEJE I TEHNOLOGIJE

Vjerujemo da su najbolje tehnologije i kreativnost savršen mix kako bi proizvod bio konkurentniji. Odlični rezultati dolaze samo iz fuzije raznih ideja, stručnosti i sposobnosti. Oni su garantirani certifikatima proistekli iz proizvodnih procesa i proizvoda. Volimo projektiranje, ispitivanje i stvaranje novih rješenja.

WE KEEP INVESTING IN IDEAS AND TECHNOLOGIES

We believe the best of technology and creativity is the perfect mix for a product even more competitive. Excellent results come only from the fusion of ideas, competence and skills. They are guaranteed by certifications given to manufacturing processes and products. We love designing, testing and creating new solutions.

POMOĆI ĆEMO VAM DA POBOLJŠATE SVOJ PROIZVOD

Savršeno rješenje postiže se timskim radom, gdje su kupac i dobavljač partneri i surađuju kako bi poboljšali svoje rezultate. Pomažemo kupcima testirajući njihove proizvode u našim laboratorijama i dijelimo sa njima rezultate testova naših kvalificiranih tehničara. Naši tehnički promotori su obučeni da pomažu kupcima oko tehničkih pitanja i razvoju proizvoda. Radimo sa kupcem prije, za vrijeme i nakon prodaje.

WE HELP YOU TO IMPROVE YOUR PRODUCT

The perfect solution comes by teamwork, where the customer and the supplier are in partnership and they collaborate to improve their performances. We help the customer testing directly his products in our laboratories and sharing the test results with our qualified technicians. Our technical promoters are trained to help the customer on technical issues and product development. We work with the customer before, during and after the sale.

PROJEKTIRAMO RJEŠENJA ZA VAS

Naš proizvod is tehnoški napredni i naravno, lijepi. Konstantno istraživanje omogućava nam da se svaki pojedinačni dio proizvoda pojednostavi. Dizajn svakog dijela okova je minimalistički, jasan i linearan. Okov nije više samo strukturalni elemenat, ali smatra se i esencijalnim dijelom u konačnoj izvedbi dizajna proizvoda. Dakle, on postaje lijep i može biti prikazan.

WE DESIGN THE SOLUTION FOR YOU

Our products are technologically advanced and beautiful, too. The continue research brings us to simplify every single product part. The design of each item is minimalist, clear and linear. The hardware is not just a structural element anymore, but it's also considered an essential part for the final product design. So, it becomes beautiful and can be shown.

Alban Giacomo stariji pokreće posao u Bassanu uz pomoć svojih sinova Giorgio i Antonio. AGB proizvodi pribor za prozore i vrata.

Alban Giacomo Sr. starts up the business in Bassano with the help of the sons Giorgio and Antonio. AGB produces accessories for windows and doors.



Braća Alban prebacuju posao u novi poslovni objekat u Romano d'Ezzelino. Tvrtka konstantno raste. Alban brothers move the business to a new headquarters in Romano d'Ezzelino. The company is constantly expanding.

VREMENSKA
LINIJA

TIMELINE



1953
AGB raste i braća Alban kreću sa aktivnostima u širenju prostora radi povećanja kapaciteta proizvodnje. AGB grows and the Alban brothers move the activity to a wider premise in order to increase the production.

1980/1990
Osvajanje talijanskog i stranih tržišta: AGB ostvaruje veći udjel u prodaji na raznim tržištima i postaje lider u mnogim zemljama. The conquest of Italian and foreign markets: AGB gains bigger market share, becoming a leader in many countries.

OKOV ZA VRATA / ACCESSORIES FOR DOORS



10

BRAVE

Širok asortiman brava za ulazna i unutrašnja vrata, dostupan u mnogim modelima i za sve vrste potreba: unutrašnja vrata, ulazna vrata, klizna vrata, WC vrata. Moguće ih je kombinirati sa AGB Scudo i PS cilindrima koji imaju U-ojačanje od nehrđajućeg čelika i kontrolu kopiranja ključeva. Sistem kontrole pristupa Opera Bit je savršen za hotele i javne ustanove.

LOCKS

Range of locks for entrance and interior doors, available in many models and for all application types: interior doors, entrance doors, sliding doors and bathroom doors. It is possible to combine them with AGB SCUDO and PS cylinders with stainless steel U-shaped reinforced insert and duplicated controlled key. The access control system OPERA BIT is perfect for hotels and communities.



22

CILINDRI

Kompletna serija sigurnosnih cilindara Euroskog profila, proizvode se prema standardu UNI 9570. Scudo i PS cilindri u više različitih nivoa pasivne i aktivne sigurnosti, dvostrani, sa visoko otpornim mesingom i niklovanim ključevima. TENAX zaštita za cilindar garantira još bolju protuprovalnu zaštitu.

CYLINDERS

Complete series of European profile security cylinders, all produced in conformity with UNI 9570 standard specifications. The SCUDO and PS cylinders provide incremental levels of passive and active security. Non-handed, high-resistance brass and nickel silver keys. TENAX protective rim guard guarantees even higher anti-burglar protection.



26

SPOJNICE

Spojnice, uglavnom sekundarni element prozora i vrata, u ovom slučaju imaju važan značaj radi pokretanja vrata. AGB nudi spojnice za sve vrste prozora i vrata: od jednostavnih spojnica za drvene okvire do složenih i kompleksnih spojnica, sa 3D podešavanjima.

HINGES

The hinges, normally a secondary element of windows and doors, are instead one of the most important components as they are decisive for the moving. AGB proposes hinges for all types of windows and doors: from simple hinges for wooden frames to up-to-date and complex adjustable hinges, with three possible dimensional adjustments.



38

BRAVE SA VIŠE TOČAKA ZATVARANJA

Brave sa više točaka zatvaranja su najbolja opcija za zadržavanje ulaznih i francuskih vrata. Brzo se montiraju i imaju više točaka zaključavanja, sa rolnicama, kukama i riglama, koje povećavaju sigurnost vrata. Dostupni modeli: Sicurtop funkcija preko cilindra, Unitop funkcija preko kvake.

MULTIPOINT LOCKS

The Multipoint locks are the best solution for the closing of entrance and french doors. The contemporaneous fastening on more locking points, with locking cams, hooks and bolts, remarkably improves the door security. Models available: SICURTOP operated by the cylinder, UNITOP operated by the handle.

AGB otvara novo visoko kompjuterizirano skladište u Cassola. AGB opens a new highly computerized warehouse in Cassola.



Giacomo i Alessandra Alban, sa istom strašću kao i njihov otac Giorgio i stric Antonio, preuzimaju cjelokupno upravljanje tvrtkom, osiguravši time kontinuitet vrijednosti i misiju. Giacomo and Alessandra Alban, with the same passion of their father Giorgio and their uncle Antonio, undertake the general management of the company, ensuring continuity to AGB values and mission.

AGB širi proizvodni pogon Cassola. AGB extends the production plant in Cassola.

2005

2008

2005/2012

2015



AGB otvara treću tvornicu u Pove. Odjeljenje visoke tehnologije, posvećeno proizvodnji visokoj kategoriji sigurnosnih cilindara. AGB opens the third plant in Pove. A high tech department dedicated to the production of high security cylinders.

AGB otvara 4 ogranka u inozemstvu: AGB SL Logroño (Španjolska), AGB Ital centar (Srbija), AGB EST Pltd (Bugarska), AGB Tianjing (Kina). AGB opens 4 branches abroad: AGB SL Logroño (Spain), AGB Italcentar (Serbia), AGB EST Pltd (Bulgaria), AGB Tianjing (China).



PRIBOR ZA PROZORE / ACCESSORIES FOR WINDOWS



42

OKOV ZA PROZORE

AGB je dizajnirao sistem okova koji je nazvao ARTECH kako bi zadovoljio sve potrebe stolara. Personaliziran za kupce, sa standardima visokog kvaliteta, pažnjom talijanskih rješenja, sistemom modularnosti, laboratorije za testiranje proizvoda i protuprovalnih elemenata kao standardna ponuda da bi kupcu pružili vrhunski proizvod.

HARDWARE FOR WINDOWS

AGB designed a hardware range called ARTECH to satisfy all the joiner needs. The personalization for customers, the high-quality standards, the attention to the Italian solutions, the system modularity, the laboratories to test the products and the anti-burglar components as a standard offer a top product to the customer.



50

OKOV ZA PROZORE KOJI SE VRTE OKO SVOJE OSE

TOUR, sistem okova za rotirajuće prozore, odlikuje se brojnim projektnim mogućnostima koje ga čine jedinstvenim u domeni kvalitete i napretka. TOUR-R omogućava proizvodnju okruglih rotirajućih prozora sa zračnosti 12 mm. Zahvaljujući širokom asortimanu spojnica i prihvatnika, TOUR za četvrtaste rotirajuće prozore je kompatibilan sa svim sistemima proizvodnje, sa tradicionalnim ili duplim brtvama.

HARDWARE FOR PIVOT WINDOWS

TOUR, hardware system for pivot windows, distinguishes for a number of project opportunities that make it unique for quality and advantages. TOUR-R enables to manufacture circular pivot windows with gap 12. Thanks to a wide range of strikers and hinges, TOUR for rectangular pivot windows is compatible with all systems: traditional, with double gaskets or pre-milled ones.



52

KLIZNI SISTEMI

Najbolje su rješenje za pokretanje teških krila velikih dimenzija. Postoje dva tipa proizvoda: Podizno klizni sa kliznim pokretanjem u otvaranju/zatvaranju vrata i sistem Galileo u kojem se kombinira klizno pokretanje sa otklopnim za bolju i sigurniju ventilaciju prostorije.

SLIDING SYSTEMS

The best solution in order to move great and heavy sashes. There are two types of products: Lift & Slide with a sliding movement for opening and closing of the doors and the coplanar system Galileo that combines a sliding movement with a tilt opening system for a better and safer ventilation of the room.



60

OKOV ZA GRILJE I ŠKURE

Cijeli jedan asortiman proizvoda proučen je da bi zadovoljio sve zahtjeve i vrste sistema. ABACO proizvodi proširuju i kompletan katalog čine bogatijim, koji zadovoljava svako građevinsko rješenje.

HARDWARE FOR SHUTTERS

A whole product range properly designed in order to satisfy all the requirements and shutter types. The ABACO products broaden and make a complete catalogue more precious, satisfying any building solution.

OKOV ZA VRATA
ACCESSORIES FOR DOORS



brave
locks

10



cilindri
cylinders

22



spojnice
hinges

26



BRAVE LOCKS

Široka ponuda brava za ulazna i unutarnja vrata, dostupna u mnogim modelima i za sve vrste potreba: unutarnja vrata, ulazna vrata, klizna vrata, WC vrata. Moguće ih je kombinirati sa AGB Scudo i PS cilindrima koji imaju U-ojačanje od nehrđajućeg čelika i kontrolu kopiranja ključeva. Sistem kontrole pristupa Opera Bit je savršen za hotele i javne ustanove.

Range of locks for entrance and interior doors, available in many models and for all application types: interior doors, entrance doors, sliding doors and bathroom doors. It is possible to combine them with AGB SCUDO and PS cylinders with stainless steel U-shaped reinforced insert and duplicated controlled key. The access control system OPERA BIT is perfect for hotels and communities.



LEGENDA LEGEND

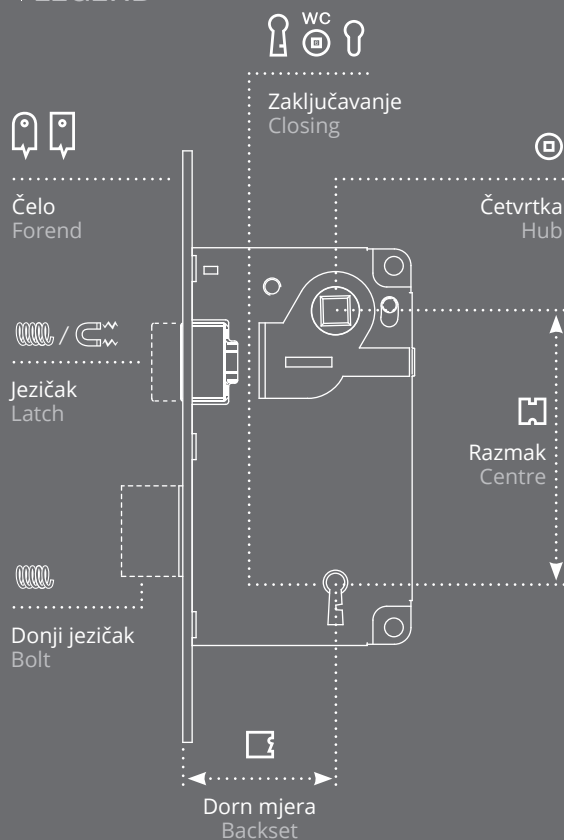

UGRADNE BRAVE MORTICE LOCKS



- 90 mm (U)
- 96 mm (WC)
- 85 mm (U)
- 18 mm
- 35/50/60 mm
- 8 mm
- čelik / steel

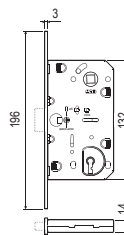

POLARIS 2XT



Polaris 2XT je brava sa magnetnim pokretom. Posebno je pogodna za moderna unutarnja vrata, suvremenog dizajna i čistih linija.

Polaris 2XT is a magnetic movement lock. It is particularly suitable for modern internal doors, thanks to its 'lean' look design.



- 90 mm (U)
- 96 mm (WC)
- 85 mm (U)
- 18 mm
- 50/60/70 mm
- 8 mm
- zamak, čelik
zamak, steel

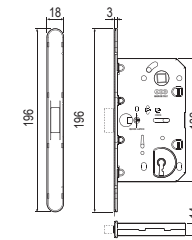

REVOLUTION XT

Jezičak sa magnetnim pokretom: dizajniran i tih. Čelo je promjenljivo sa laganim pritiskom. Moguće je prilagoditi bravu prema sopstvenom stilu.

Design and silence: latch with magnetic movement. The forend can be applied with little pressure. It's possible to customize the lock with style.

VRSTE PRIHVATNIKA ZA / STRIKERS RANGE FOR: POLARIS 2XT, REVOLUTION XT, MEDIANA EVOLUTION

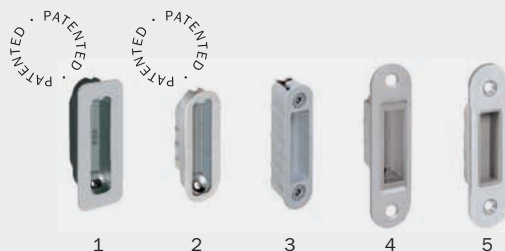

1. MINIMAL PLUS XT: Minimalistički dizajn i mogućnost podešavanja, čak i kada je prihvatnik ugrađen. / Minimal design and wide adjustments also when the striker is already installed.
2. MINIMAL XT: Minimalistički linearni dizajn. / Minimalist, linear design.
3. ALUTOP XT: Za vrata sa aluminijским okvirima. / Anchor plate for doors with aluminium frames.

4. EASY-FIX XT: Tradicionalni dizajn sa inovativnim rješenjima: metalna čeona ploča sa kadicom na klip. / Traditional design, innovative solutions: surface mounted plate and clip-in cover tray.
5. EASY-MATIC XT: Za korisnike koji preferiraju metalne prihvatnike sa tradicionalnim dizajnom. / For users who prefer traditional design solutions of metal strikers.



Testirano na otpornost na vatru i dim.
Fire resistance and smoke controlled tests.



CE oznaka za funkcionalnost prema EN 12209: zahtjevi i metode testiranja brava.
CE mark according to EN 12209: requirements and test methods for locks.



Patentirani proizvod.
Patented product.



Izdavač certifikata.
Accredited unit.



Izdavač certifikata.
Accredited unit.

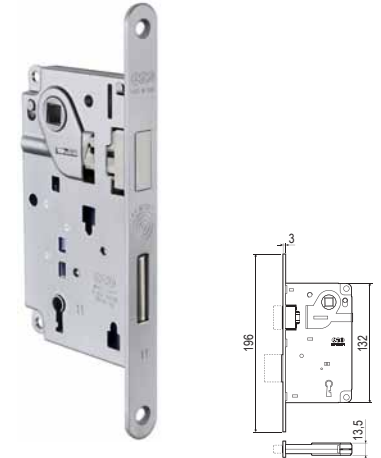
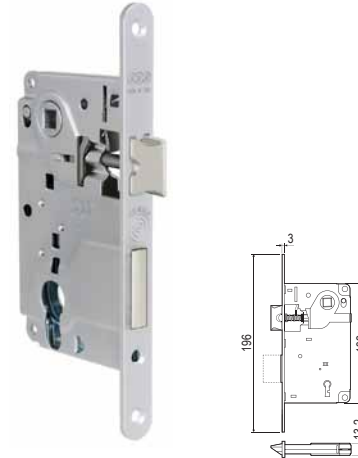
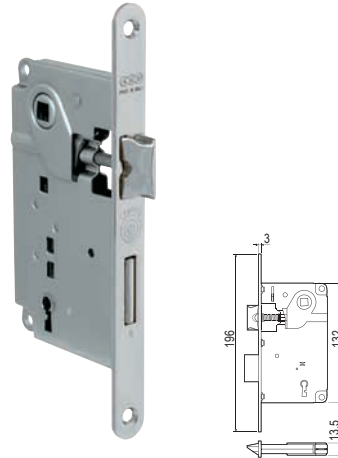
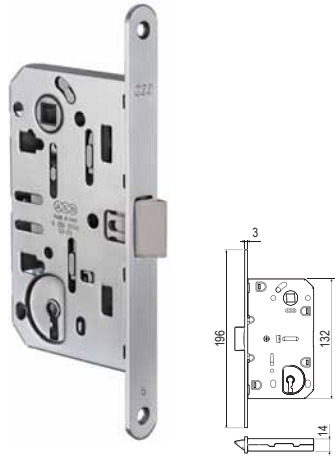

MEDIANA EVOLUTION



- 90 mm
 - 96 mm
 - 85 mm
 - 16/18 mm
 - 35/50/60 mm
 - 8 mm
- zamak, čelik
zamak, steel

CENTRO

- 90 mm
 - 85 mm
 - 18/22 mm
 - 50 mm
 - 8 mm
- čelik, mesing
steel, brass

Samo sa gornjim jezičkom, bez donjeg jezička.
Spring latch only, without bolt version also available.

CENTRO S

- 90 mm
 - 85 mm
 - 18 mm
 - 50 mm
 - 8 mm
- čelik / steel

CENTRO FOCUS

- 90 mm
 - 96 mm
 - 85 mm
 - 16/18 mm
 - 35/50/60 mm
 - 8 mm
- čelik / steel

EASY-FIX XT
Podesivi magnetni prihvatnik: montažu čini lakšom!
Adjustable magnetic striker: it makes installation easier!



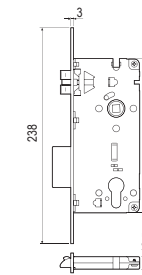
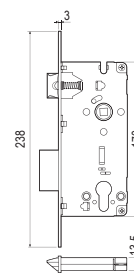
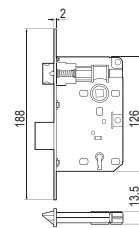
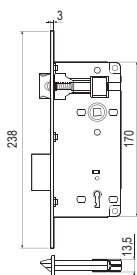

PATENT GRANDE



90 mm (WC)



92 mm (U)



18/22 mm



22 mm



25/30/35/40/45/
50/60 mm



8 mm (U)



8/9 mm (U)

čelik, mesing, inox
steel, brass, stainless steel

PATENT PICCOLA



70 mm



20 mm



25/30/35/40/45/50/60 mm



8 mm

čelik, mesing
steel, brass

SICUREZZA



85 mm



18/22 mm



16/22 mm



20/25/30/35/40/45/50/
60/70 mm



8 mm

čelik, mesing, inox
steel, brass, stainless steel

Dostupna u verziji samo sa donjim
jezičkom, bez gornjeg jezička.

Bolt only, without spring latch version
also available.

SICUREZZA SL



85 mm



22 mm



45/50/60/70 mm



8 mm

čelik / steel



UGRADNE BRAVE MORTICE LOCKS

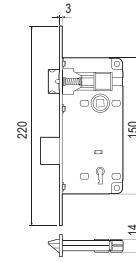
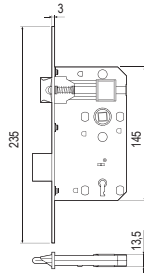
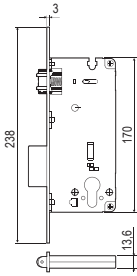

BRAVE ZA KLIZNA VRATA LOCKS FOR SLIDING DOORS



SICUREZZA SR



22 mm



40/45/50/60 mm

čelik, inox
steel, stainless steel

EURO 72



72 mm (,)



78 mm (WC)



18/20/24 mm



55 mm



8 mm

čelik / steel

ATENE



75 mm



24 mm



40/45 mm



8 mm

čelik, inox
steel, stainless steel

Jednostavna za ugradnju, u svim slučajevima velika tolerancija između kuke i prihvatnika omogućava prefektno završljivanje.

Easy to install, the wide tolerances between hook and striker allow perfect closure, in any case.

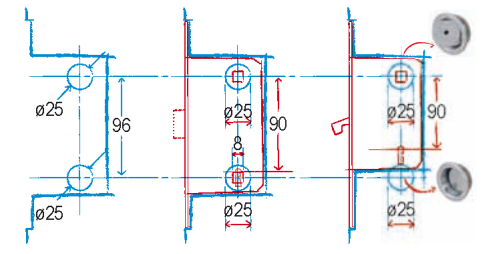
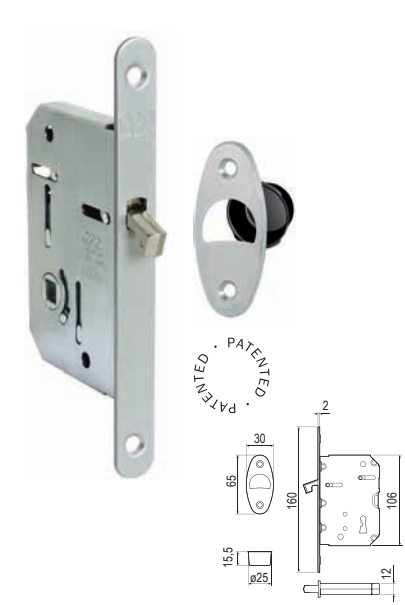





Freziranje krila
 Sash drilling
Mediana i XT
 Mediana and XT
Scivola T
 Mediana čelo
 Scivola T
 Mediana forend

SCIVOLA TT

Brava sa Poseidon sistemom za završljavanje sa dvije suprotno okrenute kuke. Štedi prostor i omogućava visoku toleranciju kuka.

Lock with Poseidon locking system with two opposite hooks. Space saving and high hooking tolerance.



-  70 mm
-  16 mm
-  50 mm
-  8 mm

čelik / steel

SCIVOLA T

Brava sa jednom padajućom kukom. Malih dimenzija.

Lock with return hook. Reduced bulk.



-  70 mm
-  16/18 mm
-  50 mm
-  8 mm

čelik / steel

SCIVOLA TRE

Zahvaljujući standardizaciji bušenja rupa, Scivola Tre omogućava da izaberete tip seta za zatvaranje: rupa za cilindar, rupa za ključ i rupa za WC.

Thanks to the standardization of the mill hole, Scivola Tre allows to choose the type of closing while executing the set up: cylinder hole, key hole and WC hub.

-  16 mm
-  35/40/50 mm

čelik / steel

VENTI5

Ručica pruža slobodnu kreativnost vrata.

- Nazubljeni prsten omogućava bolji spoj sa drvom (bez plastične baze). ①
- Minimalni i ergonomski pristisak. ②
- Ekspandirajuća četvrtka pogodna za vrata debljine 39 - 44 mm. ③

The handle that sets the door's creativity free.

- Knurled surface for a better grip on the wood (without plastic plates). ①
- Minimal and ergonomic grip. ②
- Expanding spindle suitable for doors 39 to 44 mm thick. ③

ø 25 mm

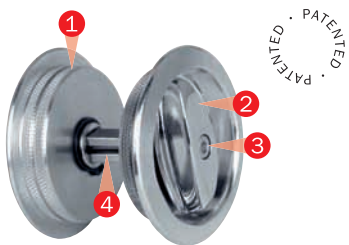

ZAVRŠNE OBRABE / FINISHES RANGE

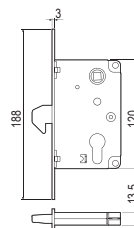
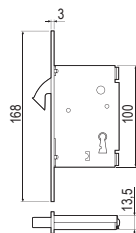

RUČICE Ø 48 mm HANDLES Ø 48 mm

- Nazubljeni prsten omogućava bolji spoj sa drvom (bez plastične baze). ①
 - Laka i funkcionalna ručica. ②
 - Vijak za fiksiranje ekspandirajuće četvrtke. ③
 - Ekspandirajuća četvrtka pogodna za vrata debljine 30 - 53 mm. ④
- Knurled surface for a better grip on the wood (without plastic base plates). ①
 - Easy and functional handgrip. ②
 - Screw for mounting the patented expanding spindle. ③
 - Expanding spindle suitable for doors 30 to 53 mm thick. ④

čelik, mesing / steel, brass

02. Svjetlo brončana/Light bronze plated
08. Mesing satinirana/Brass satin 10. Zlatno sjajna/Enamelled polished 12. Mesing antik/Antique brass 30. Kromirana sjajna/Chromium plated 32. Kromirana mat/Satin chromium 36. Inox/Stainless steel

MOD. 701

Ugradna brava sa padajućom kukom.

Embedded lock with return hook.



22 mm

30/35/40/45/50/60 mm

8 mm

zamak, čelik
zamac, steel

GANCIO

Ugradna brava sa fiksnom kukom lakšeg tipa.

Threaded lock with fixed light hook.



22/25 mm

30/35/40/45/50/60 mm

8 mm

čelik / steel

Dostupna u modelu sa kukom teškog tipa.

Also available model with heavy duty hook.

BRAVE ZA HOTELE LOCKS FOR HOTELS



Program anti-panik brava za hotele i ostale smještajne kapacitete. AGB brave su nevjerojatno tihe te pružaju mogućnost izbora kvake i dizajnirane su za protiv-dimna vrata. Sve brave imaju CE oznaku. Opera DQ je namenjena i za bolnice i javne ustanove.

Range of anti-panic locks for hotels and accomodation facilities. Incredibly silent, AGB locks offer the possibility to choose the handle and are designed for smoke resistant doors. All the locks are CE marked. Opera DQ is also suitable for hospitals and communities.



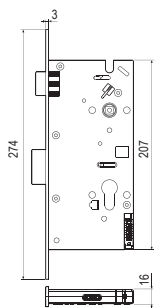

OPERA BIT

Sistem kontroliranog pristupa za hotele.
Access control system for hotels.



Jedina elektronska brava sa sistemom **DUPLO ZAKLJUČAVANJE** (magnetno pokretanje jezička i automatski donji jezičak).

The only electronic lock for hotels with **TWIN LOCK** system (magnetic movement latch and automatic bolt).

-  85 mm
-  18/22 mm
-  70 mm
-  8 mm
- čelik / steel

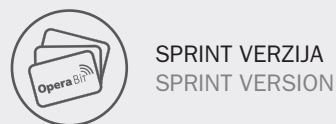
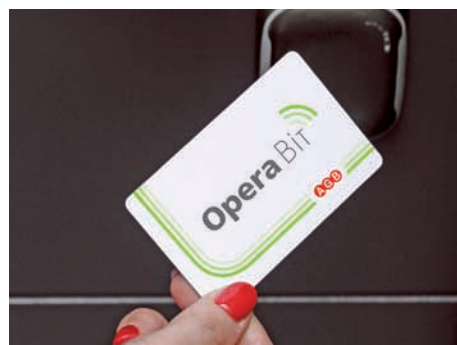
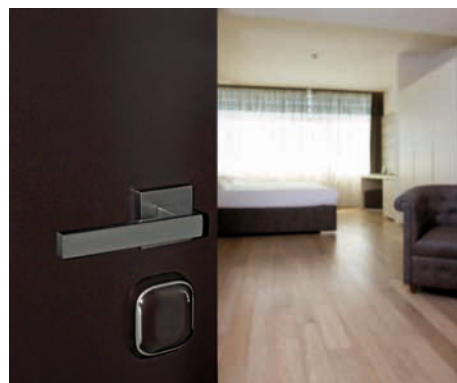
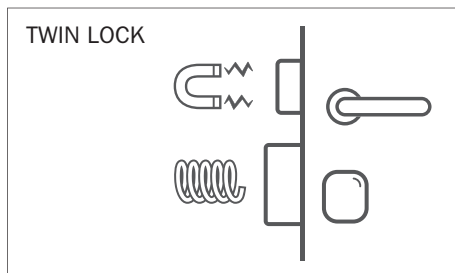

FULL VERZIJA
FULL VERSION



DIZAJN / DESIGN

- Završne obrade kapica mogu biti personalizirane.
 - Slobodan izbor kvake.
 - Suština u čelu brave.
 - Mali čitač i držač baterija.
- The cover finish can be personalized.
 - Feel free to choose the handle.
 - Essential lock forend.
 - Small reader and battery holder.



SIGURNOST / SECURITY

- Automatski donji jezičak kao standard.
 - Gumb sa funkcijom "Ne uznemiravati".
 - Anti-panic brava.
 - Cilindar za mehaničko otvaranje u slučaju nužde.
- Automatic bolt as standard.
 - Button with a "Do not disturb" function.
 - Antipanic lock.
 - Emergency cylinder for a mechanical opening.



RFID KARTICA / RFID CARD

- Bezkontaktna tehnologija RFID kartica za otključavanje brava.
 - Ne može se uništiti. Ne može se razmagnetizirati.
 - Može se koristiti za sve funkcije u hotelu.
- Contactless RFID card for the lock opening.
 - It can't be damaged. It can't be demagnetized.
 - It can be used for all the hotel functions.



SPRINT VERZIJA / SPRINT VERSION

Jednostavan pristup upravljanja uz pomoć tri specijalne kartice: Aktivacijska, Reset i Stalno otvoreno. / Simple accesses management thanks to three special cards: Activation card, Reset card and Hold-open card.



FULL VERZIJA / FULL VERSION

Sistem se sastoji od dva softvera koji upravljaju kompletnim pristupom gostiju i operatera u području soba i zajedničkih prostorija. / One system, two software. They are able to offer a complete accesses management of guests and staff, both in rooms and common areas.



Opera Bit
Check-In



Opera Bit
Manager

BRAVE ZA HOTELE LOCKS FOR HOTELS

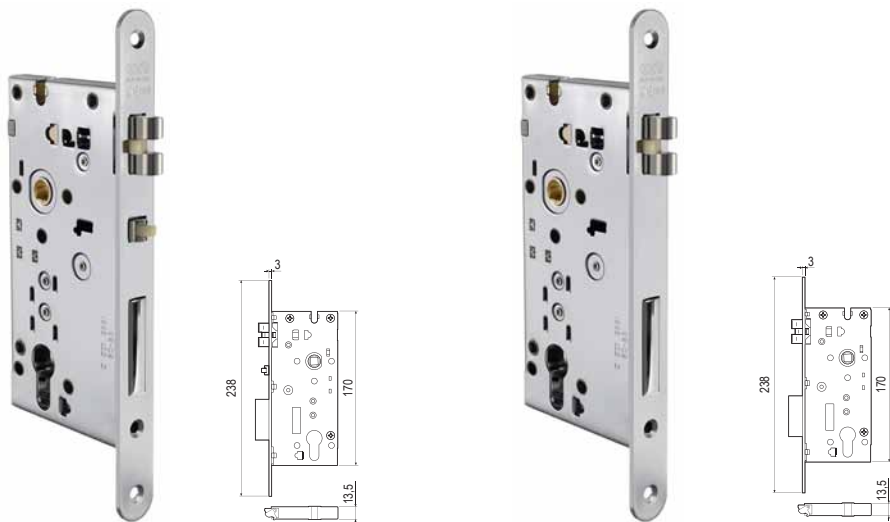

OPERA HOTEL SL



Patentirana anti-panik sigurnosna brava sa jezičkom na polugu u cilju smanjenja buke prilikom zatvaranja. Uz brave OPERA SL neophodno je koristiti AGB cilindre Opera SL.

Patented anti-panic lock with lever latch to improve silence when closing the door. OPERA SL locks must be combined with AGB OPERA SL cylinders.



85 mm

18/22 mm

50/60/70 mm

8 mm

Takođe je dostupna u verziji bez protuprovalnog elementa.
Also available without antiburglar element.

OPERA DQ SL



OPERA DQ SL brava sa dvostranim otvorom za kvaku. Antipanic funkcija aktivna je sa unutarnje strane, dok kvaka sa vanjske strane aktivira samo jezičak kvake.

OPERA DQ SL lock with split-spindle. The panic exit function is active in the inner side, whilst the handle in the outer side operates the spring latch only.



85 mm

22 mm

50/60/70 mm

8 mm

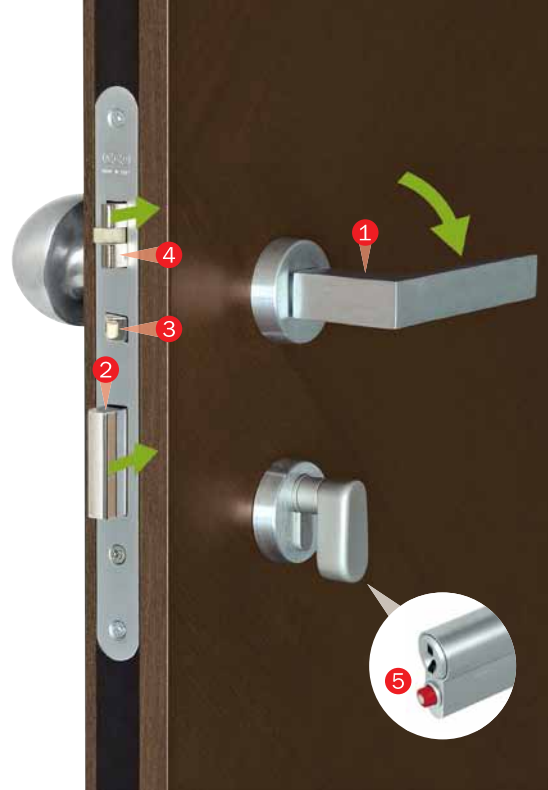

Spuštajući kvaku sa unutarnje strane ①, istovremeno se oslobađaju jezičak kvake ④ i jezičak cilindra. ②

Opera SL brave omogućavaju korištenje kvake po izboru ①. Pokazivač zauzetosti ⑤, nalazi se na cilindru.

Protuprovalni element ③ blokira povlačenje jezička kvake ④ kada gost napusti sobu, sprječavajući svaki pokušaj provala.

From inside the room, bolt ① and spring latch ④ are instantly released by simply lowering the handle ② for the immediate opening of the door.

OPERA SL lock allows you to use any type of handle ①. The occupancy indicator ⑤ is not located on the plate but directly on the cylinder.

Anti-thrust latch ③ hinders retraction of spring latch ④ after the guest has left the room, thus inhibiting any break-in attempt.

KLJUČEVI KEYS	Rotacija Rotation	Soba / Room	
		Slobodna Vacant	Zauzeta Occupied
Direkcija Manager	Kompletna Complete	→ ←	→ ←
Servis Service	Limitirana Limited	→ ←	→ ←
Klijent Customer	Limitirana Limited	→ ←	→ ←



OPERA CILINDRI OPERA CYLINDERS

Cilindar sa ravnim ključem i pokazivačem zauzetosti. Kada se vrata zaključaju sa unutarnje strane uz pomoć gumba, pokazivač izađe iz cilindra sa vanjske strane označavajući zauzetost sobe.

Flat key cylinder with occupancy indicator. Once the door has been closed with the bolt, the occupancy indicator comes out to highlight the presence inside the room.

BRAVE ZA STAKLENA VRATA LOCKS FOR GLASS DOORS

VITRA



ELEKTRO PRIHVATNICI ELECTRIC STRIKERS

- A) Podesivi elektro priхватnik (sa pola krilca) sa ili bez električne blokade i memorije otvaranja.
- B) Podesivi elektro priхватnik (sa cijelim krilcem) sa ili bez električne blokade i memorije otvaranja. Na njemu se nalazi podesivi priхват za protuprovalni element.
- C) Podesivi priхватnik za nefalcana vrata sa električnom blokadom, sa ili bez memorije otvaranja.
- A) Adjustable electric striker (half wing) with or without electric device and repeater.
- B) Adjustable electric striker (long wing) with or without electric device and repeater. With adjustment of anti-thrust latch striker.
- C) Adjustable striker for flush doors with electric device, with or without repeater.

čelik / steel



Univerzalna magnetna brava za staklena vrata, cilindar i WC sa odgovarajućim pokrivačima. Debljina od 10 mm omogućava nam da bravu montiramo direktno u staklo a ne nadgradno. Kompletiran je i dizajn brave, nisu vidljivi vijci na bravi kako bi brava izgledala lijepo na pogled.

Non-handed magnetic lock for glass doors. The versions for bathroom lock and cylinder lock with dedicated covers are available. The reduced 10 mm thickness let to install the lock directly into the glass. To complete the design details, no screw hole is visible in order to enhance the minimal design of the lock.

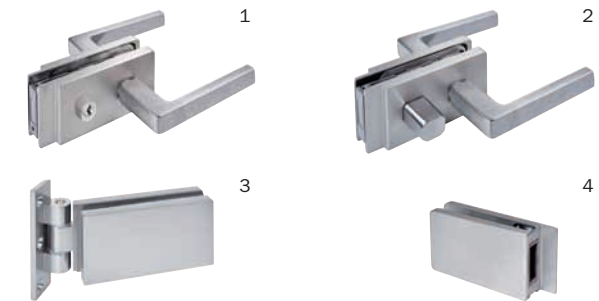

1. VITRA KIT MODEL NA CILINDAR
Novi ovalni cilindar 9000 simetričkog dizajna, projektiran je da omogućava reverzibilnost pokrивke u zadanim dimenzijama.

VITRA KIT - MODEL WITH CYLINDER

The new oval cylinder 9000 Vitra with symmetric design has been created to reach the reversibility of the cover and to limit the dimensions.

2. VITRA KIT MODEL NA GUMB
Dizajn je karakteriziran modernim linijama i osnovnim dimenzijama. Vitra sa gumbom je perfektna brava za minimalna staklena vrata.

VITRA KIT - MODEL WITH CAM

Design is characterized by modern lines and essential dimensions. Vitra with cam is the perfect lock for a minimal glass door.

3. SPOJNICA ZA STAKLENA VRATA
Dizajn nove spojnice za staklena vrata podiže vrijednost brave Vitra i savršeno koordinira linije i obrade između spojnice i brave.

HINGE FOR GLASS DOORS

The design of new hinges for glass doors enhances the Vitra lock, matching the lines and the finishes of lock and hinges perfectly.

4. PRIHVATNIK ZA DRUGO KRILO ZA STAKLENA VRATA
Dizajn i obrada priхватnika uskladjeni su sa pokrivačima brave. Priхватnik je moguće regulirati okrećući pokrivaču.

SECOND SASH STRIKER FOR GLASS DOORS

Design and finish of the striker recall the lock features. Turning the cover-tray, it's possible to adjust the striker.



03. Mesing sjajna/Enamelled brass plated
04. Žuto cinčana/Bichromated
06. Nikl sjajna/Nickel plated
08. Satinirana/Satin
12. Mesing antik/Antique brass plated
13. Nikl satinirana/Satin nickel plated
22. Brončana/Enamelled bronze plated
23. Mesing mat/Matt brass plated
34. Krom mat/Matt chromium plated.

REVERZIBILNOST BRAVE LOCK REVERSIBILITY

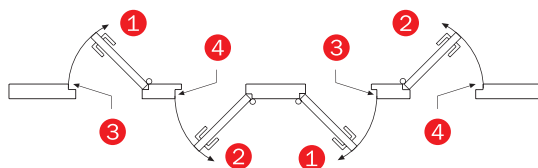

Brave se dostavljaju sa otvaranjem na desno, u suglasnosti sa normom DIN 107. Kako bi se prilagodila otvaranju na lijevo, dovoljno je okrenuti jezičak, a prema niže navedenim instrukcijama.

- DIN lijevo. ①
- DIN desno. ②
- Prihvatnik lijevo. ③
- Prihvatnik desno. ④

The locks are suitable for right-hand opening applications in compliance with DIN 107. To adapt them to left-hand doors, just turn the latch as described below.

- Left-hand DIN. ①
- Right-hand DIN. ②
- Left-hand striker. ③
- Right-hand striker. ④

SAMOPODESIVI JEZIČAK SELF ADJUSTING SPRING LATCH

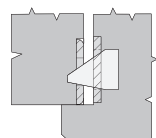

A) NORMALNA POZICIJA
Zaobljena strana jezička vrši konstantan pritisak na unutarnji otvor prihvatnika.

A) NORMAL POSITION
The round faces of spring latch apply a constant pressure against the striker label.

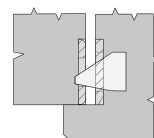

B) VANJSKA POZICIJA BRAVE
Jezičak ima skraćenu kretnju, ali ipak ulazi u otvor prihvatnika.

B) EXTERNAL LOCK POSITION
The spring latch has a shorter travel but still penetrates in the striker hole.

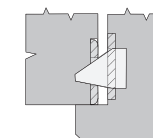

C) UNUTARNJA POZICIJA BRAVE
Jezičak ima dužu kretnju pri ulazu i na taj način omogućava pritisak na otvor prihvatnika.

C) INTERNAL LOCK POSITION
The spring latch increases its travel until both faces press against the striker hole.



CILINDRI CYLINDERS

Kompletna serija sigurnosnih cilindara Evropskog profila, proizvode se u skladu sa specifikacijama po standardu UNI 9570. Scudo i PS cilindri u više različitih nivoa pasivne i aktivne sigurnosti, dvostrani, sa visoko otpornim mesingom i niklovanim ključevima. TENAX zaštita za cilindar garantira još bolju protuprovalnu zaštitu.

Complete series of European profile security cylinders, all produced in conformity with UNI 9570 standard specifications. The SCUDO and PS cylinders provide incremental levels of passive and active security. Non-handed, high-resistance brass and nickel silver keys. TENAX protective rim guard guarantees even higher anti-burglar protection.



VODIČ ZA IZBOR CILINDRA GUIDE FOR THE CYLINDER CHOICE

Da bi se odlučili za odgovarajući model cilindra, prezentiramo grafički prikaz za sve dostupne modele.
To identify the most suitable cylinder for your needs, we introduced an easy diagram for every available cylinder.

PROTUPROVALNOST / ANTI-BURGLAR

Označava stupanj otpornosti na napad sa do sada poznatim metodama a po normama EN 1303. It indicates the resistance level to the attack with the anti-burglar methods known until now and considered by the regulation EN 1303.

SISTEMI / SYSTEMS

Označava broj mogućih kombinacija za svaki cilindar koristeći norme EN 1303 i razinu teškoće kopiranja ključeva. It indicates the number of possible combinations for every cylinder according with the regulation EN 1303 and the level of difficulty in the key duplication.

TRAJANJE / DURATION

Označava otpornost cilindra na broj ciklusa otvaranja i zatvaranja prema normama EN 1303. It indicates the cylinder resistance in relation to the number of opening and closing cycles in compliance with the regulation EN 1303.

ZAVRŠNA OBRADA / FINISH

Označava nivo otpornosti na toplotne i atmosferske uticaje prema regulativi EN 1303. It indicates the resistance level to thermal and climate stresses, as provided by the regulation EN 1303.



Testirano na otpornost na vatru i dim.
Fire resistance and smoke controlled tests.



Izdavač certifikata.
Accredited unit.



Certifikat kvalitete i sigurnosti proizvoda uvezenih u Rusiju.
Security and quality certification of the imported products in Russia.



Nizozemski certifikat protuprovalnih svojstava.
Dutch certification on the anti-burglar resistance.

CILINDRI CYLINDERS

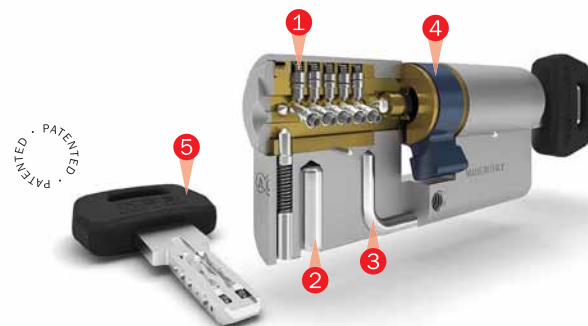

SCUDO DCK

- Duplikacija ključa kontrolirana od AGB-a i zaštićena PIN kodom.
- 15 radialno postavljenih asimetričnih pinova od nehrđajućeg čelika i fiskni pinovi za aktivaciju ključa. ①
- Čelični pin protiv bušenja. ②
- Sigurnosno ojačanje protiv lomljenja od specijalnog čelika. ③
- Jezičak protiv čupanja od posebnog čelika. ④
- 5 plosnatih dvostranih ključeva. Specijalna ergonomski oblikovana drška patentirana od strane AGB-a. ⑤
- Dostupna dupla funkcija (2 ključa istovremeno u cilindru).
- Pogodno za protupožarna vrata.

- Duplicated controlled key and protected by a PIN code.
- 15 radial and asymmetric pins in stainless steel and fixed pins to activate the key. ①
- Anti-drill pin in steel. ②
- Antiburglar insert in special steel. ③
- Anti-pull cam in sintered steel. ④
- 5 flat reversible keys. Special ergonomic grip patented by AGB. ⑤
- The double function is available (2 keys inserted at the same time).
- Suitable for fire and smoke resistant doors.



6/6



6/6



6/6



6/6



Gost-R



EN 1303



EN 1634

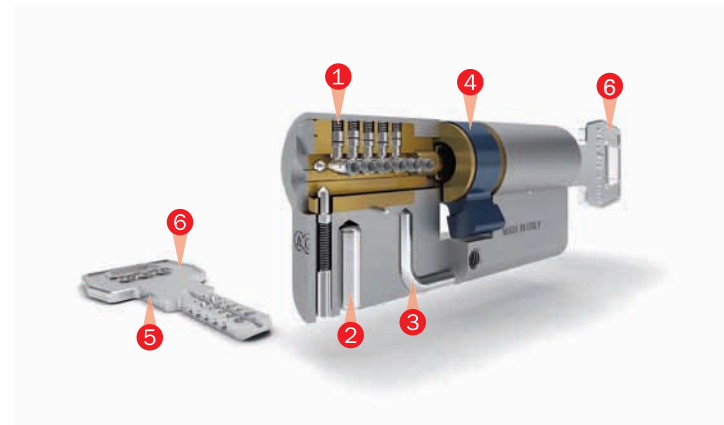

SCUDO 9000

- 17 aktivnih i pasivnih pinova od nehrđajućeg čelika. ①
- Čelični pin protiv bušenja. ②
- Ojačanje od nehrđajućeg čelika u obliku slova U za prevenciju čupanja u slučaju oštećenja nastalih prilikom pokušaja provale. ③
- Jezičak protiv čupanja od posebnog čelika. ④
- 5 plosnatih dvostranih ključeva visoke otpornosti na krivljenje. ⑤
- Mogućnost personaliziranja glave ključa, kopicama u raznim bojama. ⑥
- Kartica sa kodom za duplikaciju.
- Pogodno za protupožarna vrata.

- 17 active and passive pins in stainless steel. ①
- Anti-drill pin in steel. ②
- Stainless steel reinforced element to prevent extraction in case of damage due to break-in attempts. ③
- Anti-pull cam in sintered steel. ④
- 5 resistant flat reversible keys. ⑤
- Possibility to personalise the grip with many different coloured covers. ⑥
- Card with duplication code.
- Suitable for fire and smoke resistant doors.



6/6



5/6



6/6



6/6



Gost-R



EN 1303



EN 1634

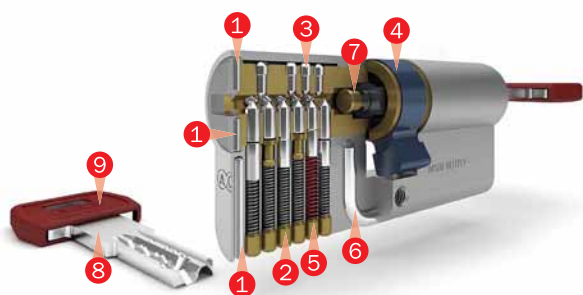

U-TECH PS

- 3 čelična pina protiv bušenja. ①
- 6 aktivnih pinova ② i 9 pasivnih pinova ③ za širok spektar kodiranja.
- Jezičak protiv čupanja od posebnog čelika. ④
- Visoka otpornost na udarac, certificirano u skladu sa ICIM 70R009. ⑤
- Ojačanje od nehrđajućeg čelika u obliku slova U: sprječava izvlačenje cilindra u slučaju pokušaja provale. ⑥
- Frikciona spojka za otvaranje vrata čak i kada je ključ ubačen sa druge strane. ⑦
- 5 plosnatih dvostranih ključeva sa dugim vratom otpornim na krivljenje i zaštitna kapica. ⑧
- Mogućnost personaliziranja glave ključa kopicama u raznim bojama. ⑨
- Kartica za duplikaciju ključa.
- Pogodno za protupožarna vrata.
- 3 anti-drill pins in steel. ①
- 6 active pins ② and 9 passive pins ③ for a wide range of coding.
- Anti-pull cam in sintered steel. ④
- High resistance to bumping, certified according with ICIM 70R009. ⑤
- Reinforced element in stainless steel: it prevents the cylinder extraction in case of break-in attempts. ⑥
- Friction coupling to open the door even when the key is inserted on the other side. ⑦
- 5 flat reversible keys with long neck that is resistant to torsion and protective rim guard. ⑧
- Possibility to personalise the grip with many different coloured covers. ⑨
- Card for the key duplication.
- Suitable for fire and smoke resistant doors.

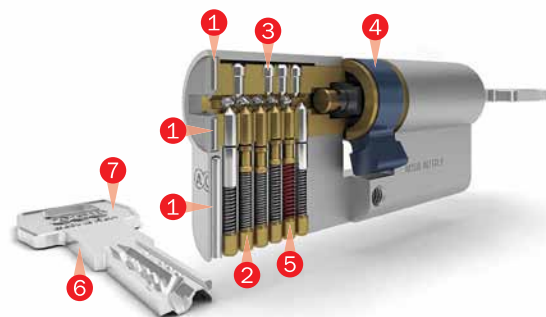

5000 PS

- 3 pina protiv bušenja sa svake strane. ①
- 6 aktivnih pinova ② i 9 pasivnih pinova ③ za širok spektar kodiranja.
- Jezičak protiv čupanja od posebnog čelika. ④
- Visoka otpornost na udarac, certificirano u skladu sa ICIM 70R009. ⑤
- 5 plosnatih dvostranih ključeva sa dugim vratom otpornim na krivljenje. ⑥
- Mogućnost personaliziranja glave ključa kopicama u raznim bojama. ⑦
- Dostupna dupla funkcija (2 ključa ubačena istovremeno).
- Pogodno za protupožarna vrata.
- 3 anti-drill pins in steel on each side. ①
- 6 active pins ② and 9 passive pins ③ for a wide range of coding.
- Anti-pull cam in sintered steel. ④
- High resistance to bumping, certified according with ICIM 70R009. ⑤
- 5 flat reversible keys with long neck that are resistant to torsion. ⑥
- Possibility to personalise the grip with many different coloured covers. ⑦
- Available with double function (2 keys inserted in the same time).
- Suitable for fire and smoke resistant doors.

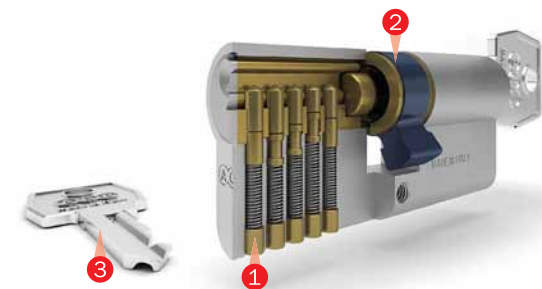

MOD. 600

- 4 ili 5 mesing pinova za kodiranje. ①
- Jezičak protiv čupanja od posebnog čelika. ②
- 3 profilirana niklovana ključa od mesinga. ③
- Velika mogućnost postojećeg kodiranja.
- Pogodno za protupožarna vrata.
- 4 or 5 pins in brass for the coding. ①
- Anti-pull cam in sintered steel. ②
- 3 profiled nickel plated brass keys. ③
- Wide possibility of existing coding.
- Suitable for fire and smoke resistant doors.







































KAPICE / COVERS

Ključ može biti personaliziran pomoću širokog spektra zamjenjivih kapica dostupnih u različitim bojama.

The key can be personalised with a wide range of interchangeable covers, available in different colours.



PONUĐA CILINDARA CYLINDERS RANGE

	SCUDO DCK	SCUDO 9000	U-TECH PS	5000 PS	MOD. 600
 ključ - ključ key - key					
 dupla funkcija ključ - ključ double function key - key					
 polucilindar half - key					
 gumb - ključ knob - key					
 osovina za gumb 18 mm - ključ 18 mm tang - key					
 osovina za gumb 63 mm - ključ 63 mm tang - key					
 gumb - novčić knob - emergency					
 polucilindar sa gumbom half - knob					

ZAVRŠNE OBRADJE FINISHES RANGE



01

08

10

12

72

02

06

16

34

13

SISTEMI SYSTEMS

KA

KA Sistem istih ključeva
Key alike system

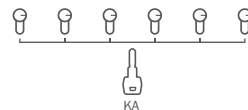

MK

MK Sistem sa master
ključem
Master key system

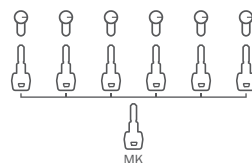

GMK

GMK sistem sa generalnim
master ključem
General master key
system

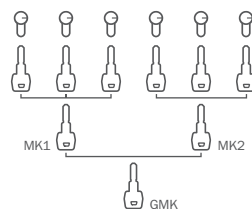

CC

CC Sistem sa centralnim
cilindrom
Central cylinder system

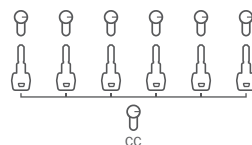

CCMK

CCMK Sistem centralnog
cilindra i master ključa
Central cylinder system
and master key

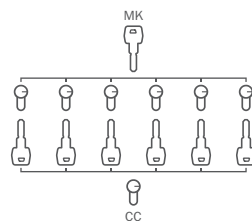

ZAŠTITA PROTECTION



TENAX

- Geometrijski oblik sa zakošenim površinama onemogućuje da se prihvati alatom za provaljivanje.
- Jedinstveno tijelo zahvaljujući površini od specijalnog čelika.
- Površina otporna na grebanje i otpornost na koroziju od preko 1000 sati izloženosti na posolicu.
- Dostupno u Okrugloj i Ovalnoj verziji: 5 varijanti sa debljinama od 10 do 18 mm.
- Završne obrade krom satinirani i zlatni PVD.
- Pogodno za sve AGB cilindre sa plosnatim dvostranim ključem.

- The oblique plane geometric form makes it completely tool-proof.
- Unique body thanks to the surface in special steel.
- Anti-scratch surface and corrosion resistant in salt spray over 1000 hours.
- Available in Round and Oval versions: 5 variations with thicknesses from 10 to 18 mm.
- Finish in satin chromium plated and glided PVD.
- Suitable for all the AGB cylinders with flat reversible key.

nehrđajući čelik / stainless steel

01. Prirodna/Plain 02. Brončana/Bronze plated 06. Nikl sjajna /Nickel plated 08. Mesing satinirana/Satin 10. Zlatno sjajna/Enamelled 12. Mesing antik/Antique brass plated 13. Nikl satinirana/Satin nickel plated 16. Nikl mat/Matt nickel plated 34. Krom mat/Matt chromium plated 72. Mesing antik sjajna/Antique brass glossy



SPOJNICE HINGES

Spojnice, inače sekundarni element prozora i vrata, jedna su od najvažnijih komponenti i neophodni su za pokretanje krila. AGB u svom asortimanu nudi sve vrste spojnice za prozore i vrata i to od jednostavnih dvokrakih spojnice za drvene okvire do kompleksnih podesivih spojnice, sa mogućnošću podešavanja u tri pravca.

The hinges, normally a secondary element of windows and doors, are instead one of the most important components as they are decisive for the moving. AGB proposes hinges for all types of windows and doors: from simple hinges for wooden frames to up-to-date and complex adjustable hinges, with three possible dimensional adjustments.



LEGENDA LEGEND

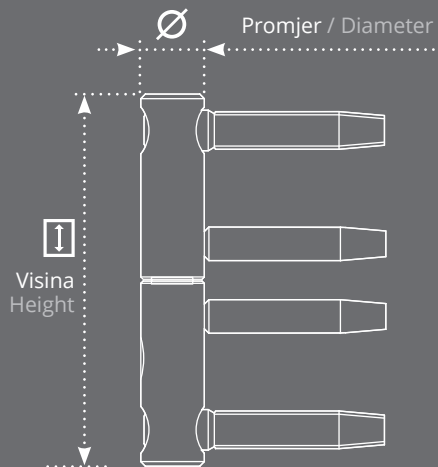

 Spojnica za drvo / Hinge for wood



EN 1634

Protupožarni testovi.
Fire resistance and smoke controlled tests.



EN 1935

CE oznaka prema EN 1935: zahtjevi i metode testiranja spojnice.
CE mark according to EN 1935: requirements and test methods for hinges.

SPOJNICE ZA RAVNA VRATA BEZ FALCA HINGES FOR FLUSH DOORS

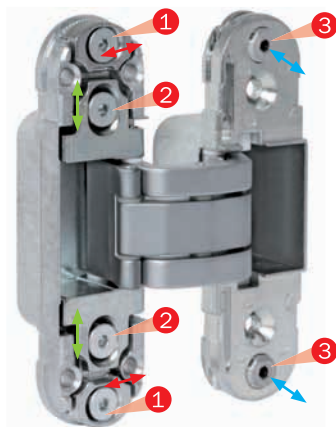

ECLIPSE 2.0



- Skrivena spojnica za ravna vrata, pogodna za teleskopsko otvaranje.
- Nevidljiva izvana, profinjenost u dizajniranju vrata.
- Spojnica je reverzibilna i zahvaljujući simetričnom frezanju omogućava na licu mjesta izbor smjera otvaranja.
- Jednostavna ugradnja: krilo i okvir mogu se sastaviti odvojeno tijekom proizvodnje i spojiti se na licu mjesta.
- Kapice skrivaju vijke za podešavanje, čine je elegantnom i kada je krilo otvoreno.
- Podešavanje na pritisak: ± 1 mm ①, vertikalno podešavanje: ± 2 mm ② horizontalno podešavanje: ± 1.5 mm ③.

- Concealed hinge for flush doors, suitable for telescopic coverplates.
- Invisible from outside, refinement in door design.
- Reversible thanks to symmetrical milling enabling on-site choice of door side.
- Easy installation: sash and frame parts can be assembled separately during production and joined on site.
- The covers conceal the adjustment screws, for elegance also when the sash is open.
- Pressure adjustment: ± 1 mm ①, vertical adjustment: ± 2 mm ②, horizontal adjustment: ± 1.5 mm ③.

 110 mm

zamak

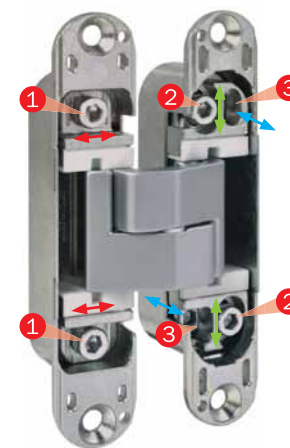

ECLIPSE 3.0



- Skrivena spojnica za vrata bez falca sa preklopom i aluminijska vrata. Pogodna za teleskopsko otvaranje. Kompletно nevidljiva zahvaljujući smanjenju dimenzija.
- Jednostavna ugradnja: krilo i okvir mogu se sastaviti odvojeno tijekom proizvodnje i spojiti se na licu mjesta.
- Kapice skrivaju vijke za podešavanje, čine je elegantnom i kada je krilo otvoreno.
- Tri potpuno nezavisna podešavanja: podešavanje na pritisak: ± 1 mm ①, vertikalno podešavanje: ± 2 mm ② horizontalno podešavanje: ± 1.5 mm ③.

- Concealed hinge for flush doors with rebate and aluminium doors. Suitable for telescopic coverplates. Completely invisible thanks to the reduced dimensions.
- Easy installation: sash and frame parts can be assembled separately during production and joined on site.
- The covers with edges hide every defect on workings.
- Three independent adjustments: pressure adjustment: ± 1 mm ①, vertical adjustment: ± 2 mm ②, horizontal adjustment: ± 1.5 mm ③.

 115 mm

zamak

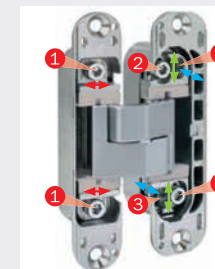

ECLIPSE 3.1



 115 mm

zamak



SPOJNICE ZA RAVNA VRATA BEZ FALCA HINGES FOR FLUSH DOORS

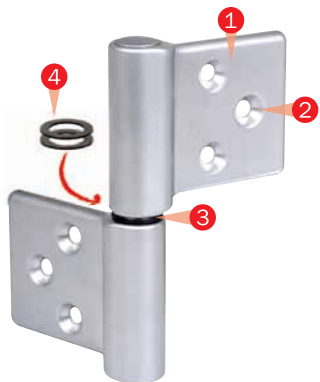

TWIN



- Reverzibilnost krila i okvira za nekoliko sekundi, bez dodatnog rada i grešaka kod ugradnje komponenata.
- Ugradnja Twin spojnice ne zahtijeva bušenje. Graničnik na unutarnjem dijelu spojnice je autošablona koja omogućava lako i precizno pozicioniranje spojnice. ①
- Tri vijka garantiraju čvrstu montažu spojnice na krilu. ②
- Metalna osovina sa najlonskim kapicama pruža maksimalnu tišinu i lakoću pokreta. ③
- Podloške nam pomažu da izbjegnemo greške prilikom montaže i omogućavaju nam vertikalno podešavanje krila. ④

- Reversibility of panel and frame in few seconds, without additional workings and mistakes while assembling the components.
- The installation of Twin does not require any milling. The cast stop on the back side of the hinge self-aligns with the door. No need for jigs. ①
- The three screws guarantee a full hinge blocking on the sash. ②
- The metallic pin covered with nylon offers maximum silence and smoothness of the movement. ③
- The washers avoid inaccuracy during the installation, allowing vertical adjustment of the sash. ④

↑ 88 mm

zamak

SPOJNICE ZA DRVO HINGES FOR WOOD



MOD. 1200



∅ 13 mm

↑ 63 mm

čelik / steel



MOD. 119



∅ 9-11-13-14-16-20 mm

↑ 37-40-45-50-51-54-67 mm

čelik, mesing, inox
steel, brass, stainless steel



MOD. 113



∅ 9-13-14-16 mm

↑ 25-36-41-46 mm

čelik / steel



MOD. 119 sa jednim zakrivljenim pinom with one bent threaded pin



∅ 14 mm

↑ 50 mm

čelik / steel



MOD. 117



∅ 13 mm

↑ 43 mm

čelik / steel



MOD. 120



∅ 9-11-13-14-16 mm

↑ 37-40-45-50-54 mm

čelik / steel



MOD. 118



Ø 13-14-16 mm
 ↓ 45-48-49-54 mm

čelik / steel



MOD. 156
 samo otklop / tilt only



Ø 13-14 mm
 ↓ 38-45 mm

čelik / steel



MOD. 198



Ø 12-14 mm
 ↓ 83 mm

čelik / steel



MOD. 3198



Ø 14 mm
 ↓ 83 mm

čelik / steel



MOD. 131/132



Ø 9-11-13-14-16 mm
 ↓ 60-74-75-88-91-98-100-102 mm

čelik, mesing
 steel, brass



TRIA



Ø 13-14-16 mm
 ↓ 38-41-44 mm

čelik / steel



TRIA MAXI



Ø 16-18-20 mm
 ↓ 60-63-88 mm

čelik / steel



Protuprovalna sigurnost, stabilnost vrata i velika mogućnost podešavanja: ovo su glavne karakteristike za montažu spojnice, koje omogućavaju da pokret vrata uvijek bude lagan.

Anti-burglar security, door stability and wide adjustments: these are the main features for the installation problems thanks to the wide adjustments, and the sash movement stays always fluid.

R4



- R4 je odgovor suvremene arhitekture: do 160 kg nosivosti sa tri spojnice. R4 omogućava vrlo brzu i laku montažu spojnice, koristeći CNC stroj i šablonu.
- R4 reducira probleme koji mogu nastati tijekom montaže sa izuzetno velikim mogućnostima podešavanja! spojnica se vrlo lako podešava kada su vrata zatvorena.
- Horizontalno podešavanje: ± 3 mm ①, podešavanje na pritisak: $0 \div 6$ mm ③ Vertikalno podešavanje: $+3$ mm, -2 mm ④.
- Stalna blokada horizontalnog podešavanja. ②
- Dva protuprovalna imbus osigurača, ne dozvoljavaju da se izvuče osovina iz tijela spojnice, u situacijama montaže izvana. ⑤
- Fiksiranje spojnice sa dva osigurača pojednostavljuje ugradnju teških krila. ⑥
- Zahvaljujući podešavanju trenja, kretanje krila može se kontrolirati korak po korak sa maksimalnom sigurnošću. ⑦

- R4 answers to the modern architecture: up to 160 kg capacity with three hinges. R4 allows a high rapid installation of hinges bodies and working fulfillment, both using the CNC machines and the jig.
- R4 reduces the problems during installation thanks to the extra-large adjustments! The hinge is easily adjustable keeping the door closed.
- Horizontal adjustment: ± 3 mm ①, pressure adjustment: $0 \div 6$ mm ③, vertical adjustment: $+3$ mm, -2 mm ④.
- Permanent block of the horizontal adjustment. ②
- The two anti-burglar grubs avoid the extraction of the installed hinge pins, in installations with external mountings. ⑤
- The fastening with two pins simplifies the installation of heavy sashes. ⑥
- Thanks to the adjustable friction, the sash movement could be controlled step by step with the maximum security. ⑦

∅ 20 mm

1 134 mm

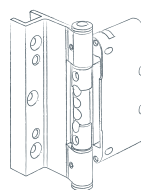

Protuprovalno Klasa 3
Anti-burglar Class 3

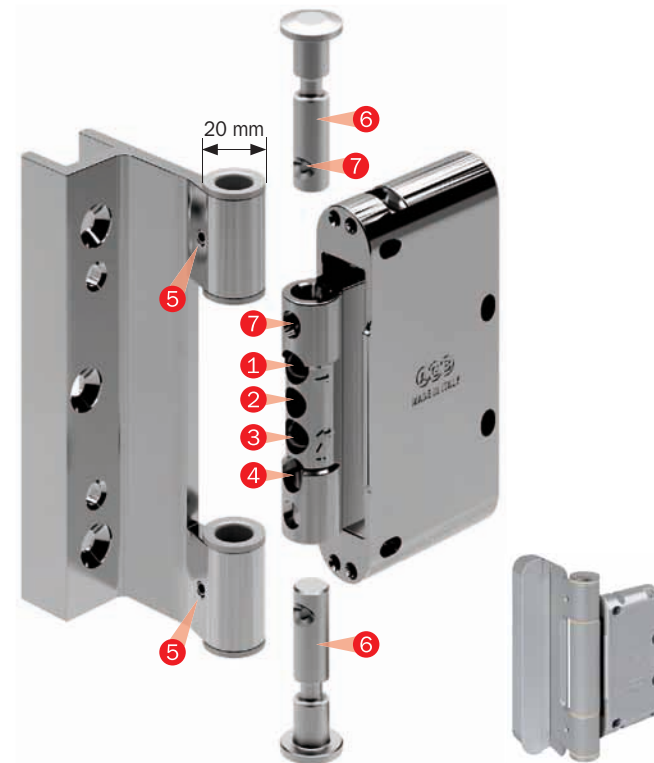

DOSTUPNI MODELI / AVAILABLE RANGE

R4
MOD. 10

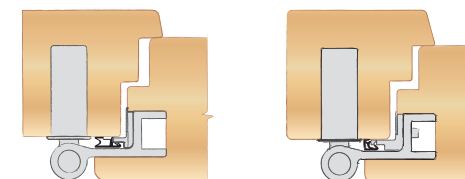

R4
MOD. 18

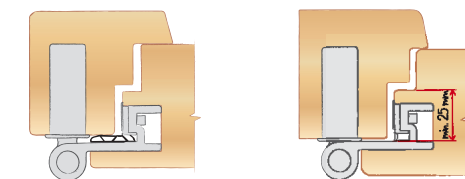

- A) Za profile sa brtvom i preklopom, 10/12 mm.
B) Za profile sa malom brtvom.
C) Za profile sa brtvom i preklopom, 15/18 mm.
D) Za profile bez brtve na preklopu.

- A) For profiles with gasket on rebate, 10/12 mm.
B) For profiles with reduced gasket.
C) For profiles with gasket on rebate, 15/18 mm.
D) For profiles without gasket on rebate.

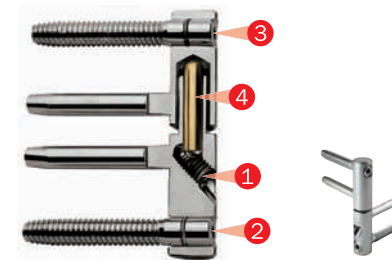
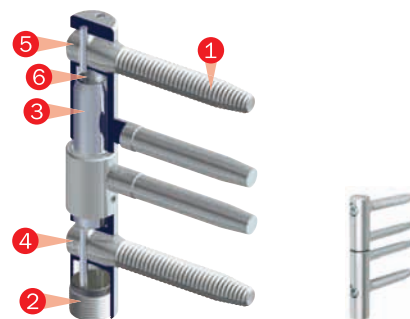
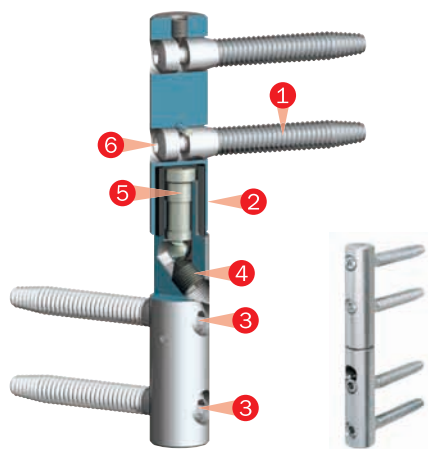

ZENIT



- Podesiva spojnica sa četiri narezana kraka. ①
- Samopodmazujući brončani sloj za maksimalnu glatkost. ②
- Podešavanje krila u pritisku sa dvostrukim reguliranjem, koje može kompenzirati eventualno popuštanje drva. ③
- Imbus vijak sa konusnim vrhom ne dozvoljava samoodvijanje prilikom vertikalnog podešavanja, te pritišće kuglicu koja je oslonac osovine. ④
- Osovina je izrađena od čelika, a kuglica od inoxa (vertikalno podešavanje do 4 mm). ⑤
- Horizontalno podešavanje krila sa dvostrukim reguliranjem, koje može kompenzirati eventualno popuštanje drva. ⑥
- Adjustable hinge with four threaded pins. ①
- Self-lubricating bronze jacket for maximum smoothness. ②
- Door pressure regulator with double adjustment to compensate any settling of the wood. ③
- Pre-treated non loosening dowel screw with tapered point for vertical adjustment, it exerts pressure on the revolving ball that supports mobile pivot. ④
- Steel pivot on stainless steel ball point (up to 4 mm vertical adjustment). ⑤
- Vertical alignment of the sash with double adjustment to compensate for any settling of the wood. ⑥

Ø 16/20 mm

Dostupan u protuprovalnoj verziji za vanjsko otvaranje.

↑ 145 mm

Anti-burglar version for outwards opening systems available.

čelik / steel

TOP



- Podesiva spojnica sa dva narezana kraka. ①
- Vijak za podešavanje po visini. ②
- Osovina je izrađena od inoxa i zaštićena je od oksidacije, sa vertikalnim podešavanjem do 6 mm. ③
- Podešavanje krila u pritisku. ④
- Horizontalno podešavanje. ⑤
- Klizna površina od kovanog čelika, omogućava minimalno trenje na osloncu i maksimalnu glatkost. ⑥
- Adjustable hinge with two threaded pins. ①
- Height adjustment screw. ②
- Stainless steel pivot ensures reliable accurate rust free coupling, up to 6 mm vertical adjustment. ③
- Compression adjustment. ④
- Vertical adjustment. ⑤
- Hardened steel revolving ball reduces friction ensuring remarkably smooth hinge movement. ⑥

Ø 16/20 mm

čelik / steel

↑ 99/111 mm

3D



- 4 mm vertikalnog podešavanja, uz pomoć vijka ① koji potiskuje pokretnu osovinu. ④
- Horizontalno podešavanje. ③
- Podešavanje krila u pritisku. ②
- Otvor spojnice obložen plastičnim samopodmazujućim materijalom, koji omogućava savršen rad spojnice čak i nakon dugog perioda nekorištenja.
- 4 mm vertical adjustment, through the thrust applied by tapered screw ① onto the revolving ball set in mobile pivot. ④
- Horizontal adjustment. ③
- Depth adjustment. ②
- Hinge hole coated with self-lubricating plastics ensure perfect hinge efficiency even after inaction for a long time.

Ø 14/16 mm

čelik, inox
steel, stainless steel

↑ 82 mm



3D-MATIC



Ø 14 mm

↑ 82 mm

čelik / steel



TRIMAX



Ø 14 mm

↑ 82 mm

čelik / steel

SPOJNICE ZA RAVNA PROTUPOŽARNA VRATA BEZ FALCA HINGES FOR FLUSH FIRE DOORS



R120



- Podesiva spojnica sa preklopnim krilcima.
- Adjustable hinge with overlapped leaves.

∅ 20 mm

↑ 111 mm

čelik / steel

R60



- Podesiva spojnica sa preklopnim krilcima.
- Adjustable hinge with overlapped leaves.

∅ 16 mm

↑ 99 mm

čelik / steel

R30



- Podesiva spojnica sa preklopnim krilcima.
- Adjustable hinge with overlapped leaves.

∅ 14 mm

↑ 65 mm

čelik / steel



03 10 04 08 02 06 30 15 34 01

01. Prirodna/Plain 02. Brončana/Bronze plated 03. Mesing sjajna/Enamelled brass plated 04. Žuto cinčana/Bichromated 06. Nikl sjajna/Nickel plated 08. Satinirana/Satin 10. Zlatno sjajna/Enamelled polished 15. Silver cinčana/Silver 30. Kromirana sjajna/Chromium plated 34. Kromirana mat/Matt chromium plated.

KAPICE
COVERS

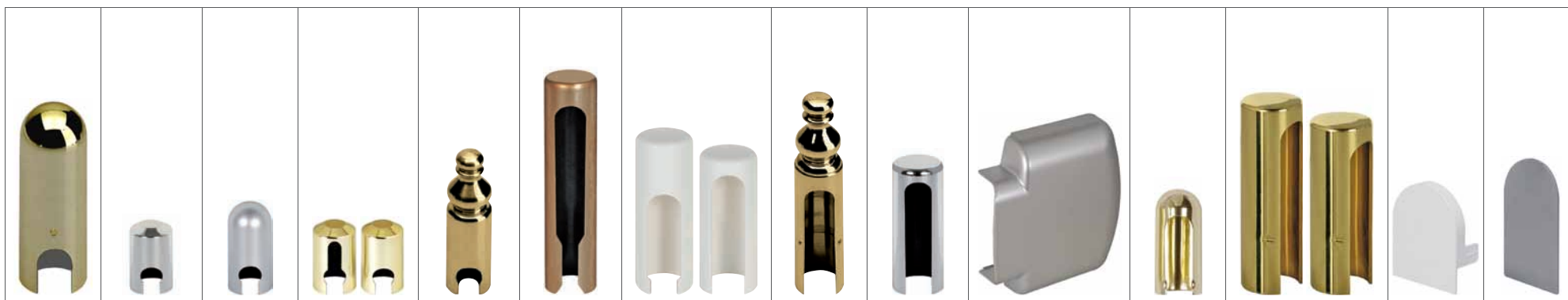

Ø	13	13, 14, 16	13, 14	14	13,14	16, 20	16, 20		14, 16	14, 16	14	14	20			
↑	68	23, 25, 26, 28, 31	30, 33	25	45, 50, 68	77, 83	57, 63	51, 57	70	46, 47, 48, 50	61	32	69	61	35	44,5
Materijal Material	aluminij aluminium	mesing / brass	ABS, aluminij / aluminium	ABS	mesing brass	ABS, mesing / brass	ABS		alamā brass	ABS, mesing / brass, aluminij / aluminium	ABS	aluminij aluminium	mesing / brass, aluminij / aluminium		ABS	ABS
Modeli Models	Mod. 1200	119, 113, 116, 117, 118, 120, 156	119, 113, 116, 117, 118, 120, 156	za treće krilo for third sash	119, 113, 116, 117, 118, 120, 156, 198	Zenit	Top		3D	3D, Trimax	Trimax	Rever	Alufix		Eclipse 2.0	Eclipse 3.0

PRIBOR ZA PROZORE
ACCESSORIES FOR WINDOWS



Brave sa više
točaka zatvaranja
multipoint
locks

38



okov za
prozore
hardware for
windows

42



okov za prozore koji
se vrte oko svoje ose
hardware for pivot
windows

50



klizni
sistemi
sliding
systems

52



okov za grilje
i škure
hardware for
shutters

60

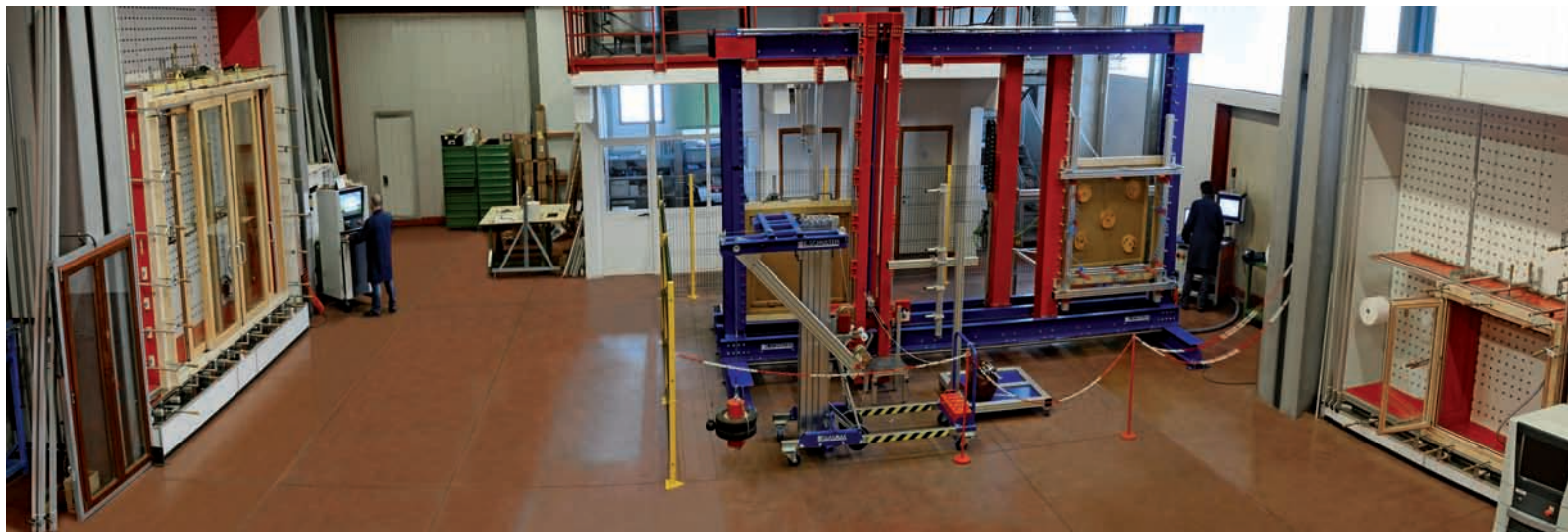

Istraživačko&Razvojni laboratorij AGBLab, omogućava testiranje proizvoda od početka kreiranja pa do samoga kraja, čime se postižu maksimalne svojstva. Kada se proizvod plasira na tržište AGBLab kontrolira svojstva i rekvizite predviđene propisima. Automatska proizvodnja garantira konstantnost odlične funkcije okova. Iz tog razloga, AGB ima ogromno iskustvo prvenstveno zbog kvalitete proizvoda, 100% made in Italy.

The Research&Development laboratory AGBLab allows to test the products from creation to development in order to ensure maximum performances. When a product enter the market, AGBLab controls the performances and the requisites provided by the regulations. The automated production guarantees the constancy of the excellent hardware features. For this reason, AGB has a high experience due to its quality products, 100% made in Italy.

Stalna ulaganja omogućavaju AGB da razvija proizvode i tvrtku uzdigne na najviši nivo kvalitete.

Da bi se osigurala maksimalna sigurnost i zaštita nivoa kvalitete, AGB ima na raspolaganju visoko kvalitetne mehanizme za testiranje prozora i vrata. Laboratorij ima na raspolaganju simulatore za testiranje komponenti protiv UV zraka i posolice.

Laboratorij je certificiran za testiranje ciklusa u skladu sa propisima EN 12209 za brave i EN 13126 za vanjske prozore i vrata. Korištenjem inovativnih materijala postiže se vrlo visok kapacitet i integritet proizvoda.

Continuous investments offered by AGB to develop the products let the company to place itself at the highest quality standards.

To ensure maximum security and protection levels, AGB has available high quality machineries to test the hardware on windows and doors. The laboratory has also simulators to test the components against UV rails and salt spray.

The laboratory certifies the hardware cycles according with the regulations EN 12209 for locks and EN 13126 for external windows and doors.

Use of innovative materials allows to realize products with high capacity and integrity.

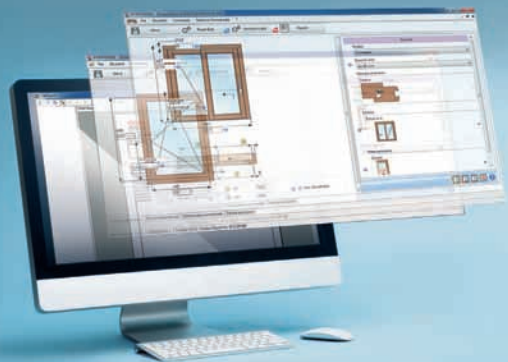

AGB 3000NG je nova generacija softvera koji služi za specificiranje AGB okova, proizvod osigurava rezervnu kopiju za stolare i distributere u svim fazama: od određivanja budžeta u svim fazama proizvodnje prozora do specificiranja isporuke okova od strane dobavljača.

AGB 3000NG is a new generation software for the calculation of AGB hardware, product providing back up for joiners and dealers at all stages: from the windows production stage to budgeting, with preparation of hardware delivery order to customer's own supplier.

AGB 3000NG KARAKTERISTIKE I FUNKCIJE

AGB 3000NG FEATURES AND FUNCTIONS

KALKULATOR OKOVA

AGB 3000NG izračunava količine, veličine i pozicije potrebnog okova za proizvodnju prozora i vrata. Možete upisati svoje prozore i vrata na listu omiljenih, tako da Vam budu lako dostupni prilikom izrade novog naloga.

- Brza i laka kalkulacija prozora i vrata.
- Čarobnjak izračunava okov.
- Tehnička dokumentacija dostupna samo jednim klikom.

RAZMJENA SA VAŠIM POSLOVNIM SOFTVEROM

AGB 3000NG razmjenjuje informacije kao što su liste okova, cijene, liste strojne obrade potrebne za izradu prozora i vrata (frezanje, bušenje, montaža...) sa vašeg poslovnog softvera.

- Jednostavno i automatsko povezivanje, pristupačno za svakoga.
- Preračunava potrebe materijala i strojne obrade, direktno iz Vašeg poslovnog softvera.
- Strojni procesi uključeni su u softveru i uvijek se čuvaju i obnavljaju od strane AGB-a.

PROCJENA TROŠKOVA

Izradite ponudu za Vaše naloge, počevši od jednog naloga ili korištenjem ponuđenih sa liste. AGB 3000NG prilagođava popuste i optimizira kvote za pakovanja ili pojedinačne dijelove.

- Procjena troškova okova.
- Cjenik se stalno ažurira.
- Mogućnost upravljanja popustima.

PODRŠKA & AŽURIRANJE

Telefonski i on-line sistem podrške biti će na raspolaganju kupcima preko VoIP-a, a biti će ga moguće koristiti i uživo pomoću inovativnih pristupa Internetu.

- Sistem automatskog ažuriranja održava program u stalnom procesu ažuriranja.
- AGB tim je vama na usluzi.
- Podrška dostupna telefonom, Skypom ili daljinskom konekcijom.

Zahvaljujući sistemu daljinske podrške, AGB tim je u mogućnosti da radi direktno na Vašem kompjuteru.

HARDWARE CALCULATOR

AGB 3000NG calculates the quantity, size, position, and hardware preparations required to create a door or window. You can organize your doors and windows in a favourites list so they are readily at hand when you need to create a new work order.

- Quick and easy door and window development.
- Hardware development wizard.
- Technical documentation just a click away.

INTERFACE WITH YOUR BUSINESS SOFTWARE

AGB 3000NG exchanges information such as the hardware list, prices and the machining required for the door or window (milling, drilling, assembly benches, etc.) with your business software.

- Simple and automatic connection affordable for all.
- Recovers the bill of material and machining processes directly from your business software.
- Machining processes included in the software and always kept up-to-date by AGB.

COST ESTIMATION

Create a quote for your orders starting from a work order or by selecting accessories from a list. AGB 3000NG customizes the discounts and optimises quotes for packs or single parts.

- Hardware cost estimation.
- Price list always up-to-date.
- Discount management tool.

SUPPORT & UPDATES

A telephone and on-line support system will be made available to customers via VoIP along with the possibility of live remote assistance using innovative Internet access tools.

- The auto update system keeps the program always up-to-date.
- The AGB team at your service.
- Support available by phone, Skype, and remote connection.

Thanks to the remote support system, the AGB team is able to work directly on your computer.



BRAVE NA VIŠE TOČAKA ZATVARANJA MULTIPOINT LOCKS

Brave na više točaka zatvaranja su najbolja opcija za zabavljanje ulaznih i francuskih vrata. Brzo se postavljaju i imaju više točaka zaključavanja, sa rolnicama, kukama i zasunima, koje povećavaju sigurnost vrata. Dostupni modeli: SICURTOP funkcija preko cilindra, UNITOP funkcija preko kvake.

The Multipoint locks are the best solution for the closing of entrance and french doors. The contemporaneous fastening on more locking points, with locking cams, hooks and bolts, remarkably improves the door security. Models available: SICURTOP operated by the cylinder, UNITOP operated by the handle.



LEGENDA LEGEND

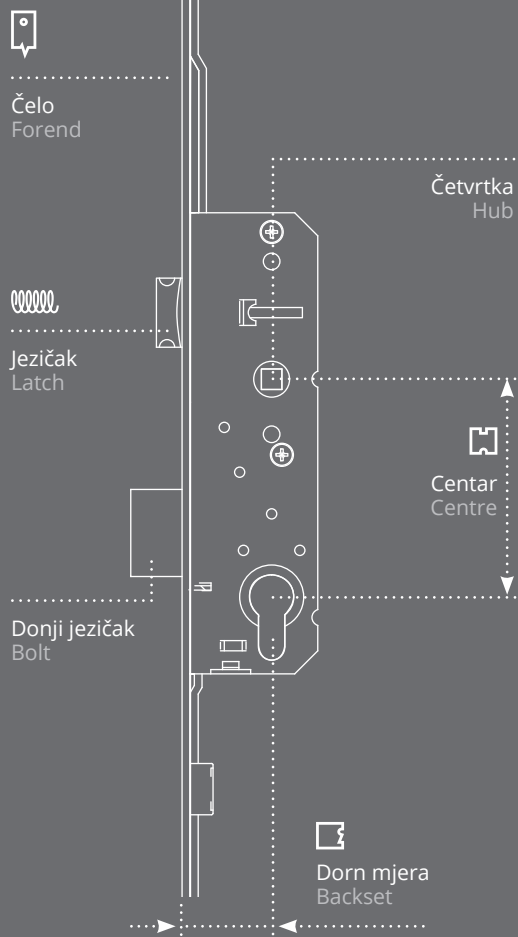

Poseidon

Jezičak + rolnica
Bolt + roller cam

Teleskopska gljivasta rolnica
Telescopic mushroom cam

Podesiva rolnica
Adjustable roller cam



SICURTOP



- Brava se zaključava u više točaka preko hladno prešanih čeličnih zupčanika.
 - Preko cilindra se zaključava donji jezičak i sve ostale točke zaključavanja.
 - Glatko i sigurnosno zaključavanje vrata sa dva okreta.
 - Kompatibilna sa nastavcima i završecima.
 - Kompatibilna sa zaštitom cilindra Tenax.
- Lock with several locking points and cold pressed steel gears.
 - The cylinder operates bolt and locking points.
 - Smoothness and security closing movement with 2 throws.
 - Compatible with terminals and extensions.
 - Compatible with protective rim guard Tenax.

85/92 mm

16/20 mm

25/30/35/40/45/50/55 mm

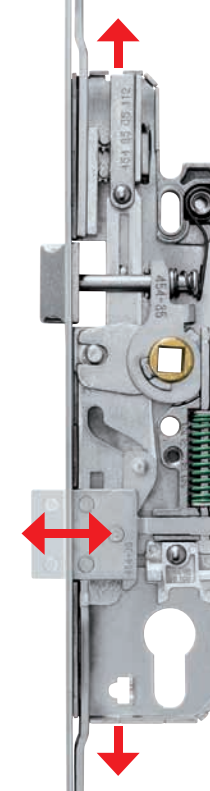

UNITOP



- Multipoint brava sa produženom kretnjom.
 - Jednostavnim podizanjem ručice omogućava se istovremeno zatvaranje u svim točkama.
 - Cilindar blokira bravu.
 - Mogućnost korištenja nastavaka i završetaka.
 - Kompatibilna sa zaštitom cilindra Tenax.
- Multipoint lock with extending movement.
 - A simple lifting of the handle operates all the locking points simultaneously.
 - The cylinder blocks the lock.
 - Available terminals and extensions.
 - Compatible with protective rim guard Tenax.

92 mm

20 mm

35 mm

BRAVE LOCKS

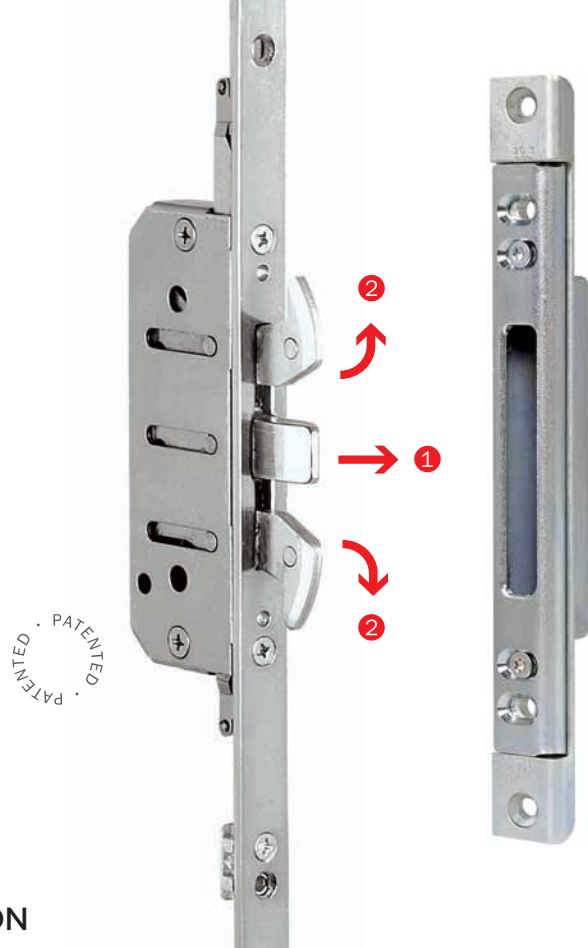

POSEIDON



- Patentirana brava sa maksimalnom protuprovalnom sigurnosti.
- Dve nasuprot postavljene kuke ① i centralni jezičak ② garantiraju čvrsta sigurnosna vrata.

- Patented lock for a maximum antiburglar security.
- Two opposite facing hooks ① and central bolt ② guarantee solidity and door security.



SKG certifikat, ekvivalent 2. nivoa zaštite reguliran EN 1627.

SKG certification, equivalent to the 2nd resistance class according to the regulation EN 1627.

OSTALE BRAVE OTHER LOCKS



JEZIČAK + ROLNICA

Rolnica ① kompletno završi svoj pokret prije nego se jezičak pokrene ②. Na ovaj način osigurano je savršeno usklađivanje i izbjegava se mogućnost trenja prilikom kretanja jezička.



BOLT + ROLLER CAM

The locking cam ① completes its run before the bolt slides out ②. In this way the uprights are perfectly aligned, preventing any friction when the bolt slides out.



TELESKOPSKA GLJIVASTA ROLNICA

Proizvedena je od čelika i specijalno oblikovana, radi povećavanja otpora prilikom zatvaranja.



TELESCOPIC MUSHROOM CAM

Made of steel and specially shaped to increase the resistance when closing.



PODESIVA ROLNICA

Optimiziran je raspored i broj rollica zavisno od dužine i modela brave. Mesingana košuljica je nezavisna i pokretna i omogućava gladak i jednostavan ulazak u prihvatnik.



ADJUSTABLE ROLLER CAM

The number and distribution of the roller-head cams are optimised in relation to the length and model of the lock.

The revolving brass jacket ensures the smooth sliding of the cam inside the striker.



ELEKTRO PRIHVATNICI

Konstantni ili parcijalni, sa memorijom za otvaranje i polugom za blokiranje.

ELECTRIC STRIKERS

Long and half wing, with repeater and manual release lever.

Zračnost / Gap 4÷12 mm



ZASUNI ZA DRUGO KRILO

Preklopni zasuni sa podesivim izlazom i integriranim prihvatnikom.

BOLTS FOR SECOND SASH

Lever bolts with adjustable throw and built-in strikers.

Zračnost / Gap 4÷12 mm



PRIHVATNICI ZA DRVENA VRATA

Kompletna paleta konstantnih ili parcijalnih prihvatnika za vrata sa ili bez falca.

STRIKERS FOR WOODEN DOORS

Complete range of single and one-piece strikers for rebated and flush doors.

Zračnost / Gap 4, 11 (8+6/8+7), 12 mm



PRIHVATNICI ZA PVC

Prihvatnici i adapteri za sve glavne PVC i aluminij-drvo profile.

STRIKERS FOR PVC

Shims and strikers for all main PVC and aluminium-wood profiles.



OKOV ZA PROZORE HARDWARE FOR WINDOWS

AGB je dizajnirao sistem okova koji je nazvao ARTECH kako bi zadovoljio sve potrebe stolara. Personaliziran za kupce, sa standardima visokog kvaliteta, pažnjom talijanskih rješenja, sistemom modularnosti, laboratorija za testiranje proizvoda i protuprovalnih komponenti kao standardna ponuda da bi kupcu pružili vrhunski proizvod.

AGB designed a hardware range called ARTECH to satisfy all the joiner needs. The personalization for customers, the high-quality standards, the attention to the Italian solutions, the system modularity, the laboratories to test the products and the anti-burglar components as a standard offer a top product to the customer.



Artech, sistem otklopno-zaokretnih okova za prozore, certificiran je garancijom kvaliteta QM328, izvršeni su vrlo strogi ciklični i sigurnosni testovi. Maksimalna nosivost od 150 kg standardna je garancija odličnih karakteristika a sistem čini efikasnim.

Artech, the Tilt&Turn system for windows, offers a certified quality hardware QM328, having succeeded strict cyclic and security tests.

The high capacity up to 150 kg as standard guarantees excellent performances and a system always efficient.



OKOV ZA OTKLOPNO ZAOKRETNE PROZORE THE TILT & TURN HARDWARE FOR WINDOWS



PRECIZNOST / PRECISION

Točka zatvaranja garantira u svakoj situaciji veliku sigurnost zahvaljujući fiksiranju glave na maloj bazi smještenoj sa prednje strane čeone pogonske trake. Nova gljivasta rolnica kao standard, omogućava vertikalno podešavanje na pritisak krila čime olakšava rad prozora.

The closure point ensures a great security seal in any situation, thanks to the fixed head and the small support on the front strip plate. The new mushroom cam as standard allows vertical and pressure adjustments, making window operations easy.



STIL / STYLE

Pogonski mehanizam je skriven iza čeone pogonske trake, zahvaljujući inovativnom sistemu izrade. Elegantni zasun na preklop integrirana je u čeonu pogonsku traku kada je prozor zatvoren.

The espagnolette mechanism is hidden behind the front strip plate, thanks to the innovative latch system. The elegant lever of the sliding bolt integrated into the front plate is hidden when the window is closed.



SIGURNOST KAO STANDARD / SECURITY AS STANDARD

Gljivasta rolnica kao standard je garancija veće sigurnosti prilikom pokušaja provale. Nivo protuprovalne sigurnosti može se prilagoditi korištenjem normalnih ili protuprovalnih prihvatnika.

The mushroom cam as standard is a warranty of greater security against break-in attempts. The level of window security can be customised using a combination of normal or anti-burglar strikers.

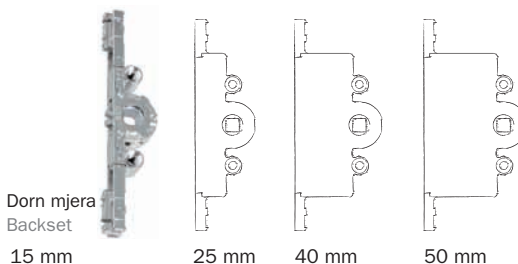

Dorn mjera
Backset

15 mm

25 mm

40 mm

50 mm

MODULARNOST / MODULARITY

Artech elementi dizajnirani su na način da racionaliziraju stanje skladišta i da odgovore konfiguraciji i potrebama svih tipova prozora.

Artech components are designed to rationalise accessory stock levels and to maintain configuration versatility for various types of windows.

RC1 ZA DRVO – PRIHVATNICI SA SKRIVENIM VIJCIMA RC1 FOR WOOD – STRIKERS WITH CONCEALED SCREWS



PRIHVATNICI SA SKRIVENIM VIJCIMA
Kapice za glave vijaka, daju nam osećaj da je prozor postao dijelom namještaja.

STRIKERS WITH CONCEALED SCREWS
The covers hiding the head of the screw make the window a furnishing element.

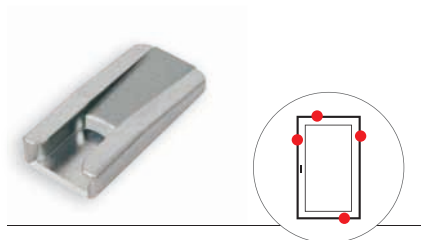

Prihvatnik rolnice
Cam striker

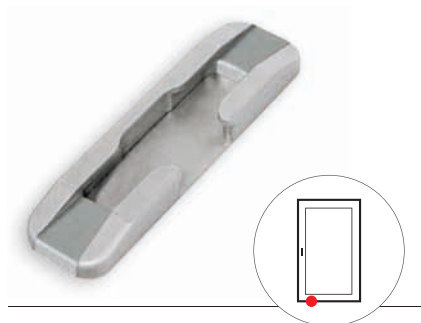

Univerzalni prihvatnik otklopa
Non-handed tilt striker

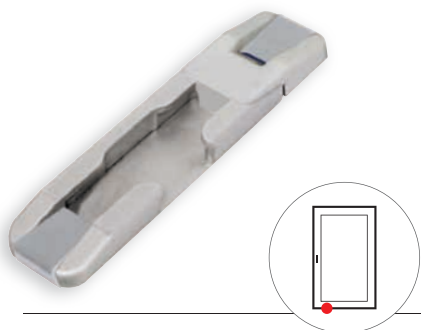

Prihvatnik otklopa sa podiznim klinom
Tilt striker with lifting wedge

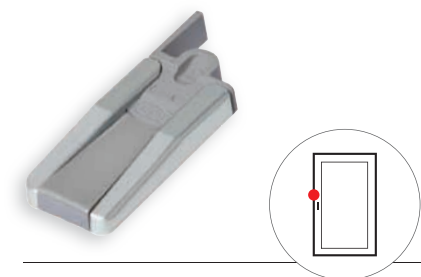

Prihvatnik protiv lažnog otvaranja
DSS striker

RC2 ZA DRVO – ARTECH ČELIČNI PRIHVATNICI ZA PROTUPROVALNI OKOV RC2 FOR WOOD – ARTECH STEEL ANTIBURGLAR STRIKERS

Velika podesivost prihvatnika
Height adjustment of cams



Otvoreni prihvatnici
Open strikers



Omogućava u radu veliku toleranciju i ispravljanje grešaka prilikom izrade
Generous working tolerances and management of installation errors

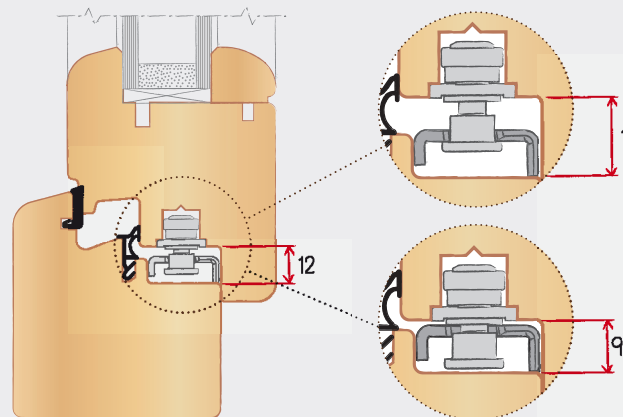

MAKSIMALNA ZRAČNOST
MAXIMUM GAP

MINIMALNA ZRAČNOST
MINIMUM GAP

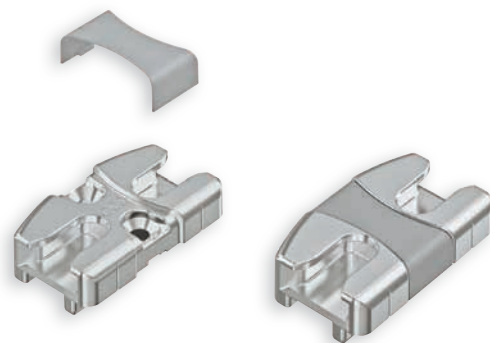
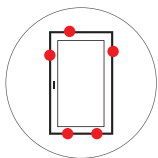

Protuprovalni prihvatnik
 Anti-burglar striker

RC2 – PRIHVATNICI ZA DRVO I DRVO-ALUMINIJ

RC2 – RANGE OF STRIKERS FOR
 PVC, ALUMINIUM AND ALUMINIUM-WOOD



RC2 ZA PVC – ARTECH ČELIČNI PRIHVATNICI ZA PROTUPROVALNI OKOV
 RC2 FOR PVC – ARTECH ANTIBURGLAR STRIKERS

Velika
 podesivost
 prihvatnika

Height
 adjustment of
 cams



Otvoreni
 prihvatnici

Open
 strikers



Omogućava u radu veliku
 toleranciju i ispravljanje
 grešaka prilikom izrade

Generous working tolerances
 and management of
 installation errors

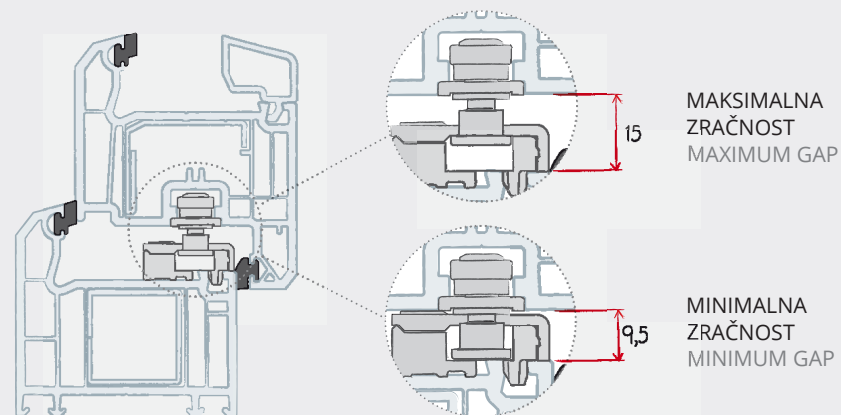



CERTIFICIRANA NOSIVOST OKOVA DO 150 KG

Artech 150 kg je dostupno za:

- Os 9/13 mm
- Zračnost 4/12 mm
- Preklop 15/18/20 mm

CERTIFIED BEARING CAPACITY UP TO 150 KG

Artech 150 Kg is available for:

- Axis 9/13 mm
- Gap 4/12 mm
- Rebate 15/18/20 mm



FUNKCIONALAN U DETALJE

Razmak između centra do centar rupe za vijke na tijelu, dizajniran je da bi se spriječilo raslojavanje i pucanje drva.

FUNCTIONAL, RIGHT DOWN TO THE LAST DETAIL

Centre-to-centre between the screw holes of the support designed to prevent shear plane and cracking of the wood grain.

VRHUNSKA TEHNOLOGIJA

Muški dio spojnice proizveden je na inovativnim automatskim strojevima za zavarivanje, zamišljen da osigura kvalitetu zavarivanja svakog elementa.

LEADING-EDGE TECHNOLOGY

The male part of the hinge has been manufactured with innovative automatic welding lines, conceived to ensure the welding quality of each item.



JOŠ JAČI

Kutna spojnica je ojačana u točki najvećeg opterećenja radi povećanja stupnja nosivosti. Dostupna u verziji sa i bez adaptera za kanal 16/12.

EVEN STRONGER

The corner hinge has been strengthened at the main stress points to increase the bearing capacity. Version with and without 16/12 adapter available.

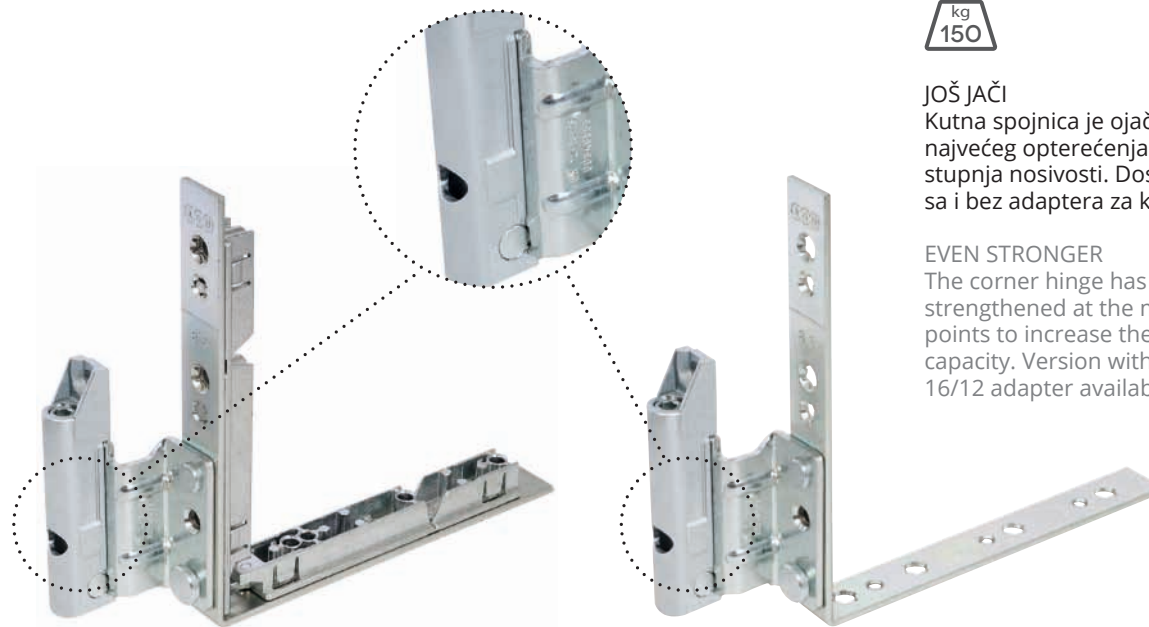

150 KG KAO STANDARD

Standardne spojnice su certificirane (samo sa dvije rupe 34, bez potrebe za specifične pinove ili elemente i bez potrebe za dodatnim vijcima u donjem dijelu spojnice).

150 KG AS STANDARD

The standard hinges (two holes 34, no specific holding pins or elements, no supplementary screws in the lower part of the male part of the hinge) are certified.



DIZAJN IZVANA, TEHNOLOGIJA IZNUTRA

Artech Plana je dostupna za:

- Drvo i PVC
- Os 9/13 mm
- Zračnost 12 mm

DESIGN OUTSIDE, TECHNOLOGY INSIDE

Artech Plana is available for:

- Wood and PVC
- Axis 9/13 mm
- Gap 12 mm



ČISTI DIZAJN

Artech Plana nestaje u okviru prozora. Omogućava da se kreiraju komplanarni prozori i vrata sa minimalnim Zračnostima između krila i okvira.

PURE DESIGN

ARTEch Plana disappears on the frame of the window. It allows to create coplanar windows and doors with minimum gap between sash and frame.

MOMENAT GLATKOSTI, UVIJEK!

Unutarnji mehanizam zaštićen je patiniranom kapićom, koja sprječava ulazak prašine u mehanizam.

A FLUID MOVEMENT, ALWAYS!

The internal mechanisms are protected by the glider cover that prevents the dust to come in.

NOSIVOST DO 150 KG

150 kg nosivosti kao oslonac za velika balkonska vrata, pruža visoke performanse u izolaciji i protuprovalnoj sigurnosti.

CAPACITY UP TO 150 KG

150 kg load capacity to support wide balcony doors, providing high performance insulation and anti-burglary security.

SPOJNICE SA AUTO-ŠABLONOM

Na drvenim prozorima, Artech Plana može se montirati na ravnom dijelu okvira bez korištenja šablona.

HINGE WITH AUTO-JIG

On wooden windows, Artech Plana can be installed on the frame seat without using any jig.



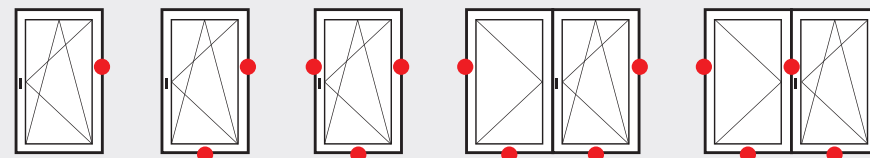

MAKSIMALNA SIGURNOST ZABRAVLJIVANJA ZA OTKLOPNO ZAOKRETNE SISTEME

Poseidon TT je dostupan za:

- Drvo i PVC
- Os 13 mm
- Zračnost 4/12 mm

THE HIGH SECURITY LOCK FOR TILT&TURN SYSTEMS

POSEIDON TT is available for:

- Wood and PVC
- Axis 13 mm
- Gap 4/12 mm

POSEIDON TT

Zahvaljujući smanjenju dimenzija, Poseidon TT zavravljivanje može se koristiti za male prostore i podržava mnoge konfiguracije.

- Dvije nasuprot postavljene kuke izlaze iz krila i zavravljaju u okviru. ①
- Protuprovalni prihvatnik za drvo sa tijelom od čelika. ②
- Protuprovalni prihvatnik za PVC sa tijelom od čelika. ③
- Inovativni sistem montiranja ④ sa kontra pločom na strani stakla, omogućava veću otpornost u odnosu na montažu sa vijcima sa prednje strane krila.

Thanks to its reduced dimensions, the Poseidon TT lock can be used on little dimensions windows and allows several configurations.

- Two facing hooks avoid the sash to unhinge from the frame. ①
- Dedicated anti-burglar striker for wood with plate in steel. ②
- Dedicated anti-burglar striker for PVC with plate in steel. ③
- The innovative fastening system ④ with the plate installed in the glass housing allows great resistance compared to the fastening with screws on the front side of the sash.

2000

VIŠE OD 2000 SATI TESTIRANO U POSOLICI. *

MORE THAN 2000 HOURS IN SALT SPRAY TEST *



(*)

Prema EN 9227 testu bez površinskih tragova korozije.

According to EN 9227 without any notch of the surface from red rust.



Primorske obalne zone
Coastal areas



Visoko zagađene zone
Polluted areas



Zone visoke vlažnosti
Moist areas

1

CINK
Štiti metal tako što radi prvu barijeru između korozivnih agensa i proizvoda.

ZINC
Protects the metal by creating a first barrier which interposes itself between corrosion agents and product.

2

KROM PASIVIZACIJA NANO ČESTICAMA SILICIJ-DIOKSIDA
Aktivno djeluje elektrokemijskim reakcijama radi zaštite cinčanog sloja a samim tim i proizvoda.

CHROMIC PASSIVATION WITH NANO PARTICLES OF SILICA
Actively acts with electrochemical reaction for the protection of the Zinc layer and thus the product.

3

AKTIVNA HERMETIČKA ZAŠTITA
Organsko-mineralni kromirani sloj. Zadržava anti-korozivne osobine u slučaju termalnog šoka i dinamičkog stresa.

ACTIVE HERMETIC PROTECTION
Organic-mineral chromating cover. Maintain the anti-corrosive characteristics even in case of thermal shocks and dynamic stress.

AKTIVNA ZAVRŠNA OBRADA VISOKE ZAŠTITE

Visoka otpornost na koroziju čak i pri najsirovijim uvjetima okoliša usljed visoke koncentracije soli u zraku (priobalna područja), zagađenja u atmosferi i u prostorijama sa velikom vlažnosti gdje se voda kondenzira i često nastaje plijesan.

ACTIVE HI-PROTECTION FINISH

High corrosion resistance even in the most inclement environmental conditions, due to high salt concentration in the air (coasts), to the atmospheric pollution and to humid rooms which take to develop condensate and moulds.

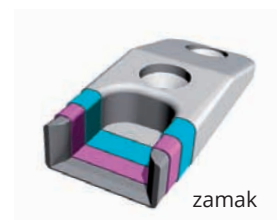

zamak



čelik / steel



OKOVI ZA PROZORE KOJI ROTIRAJU OKO SVOJE OSI HARDWARE FOR PIVOT WINDOWS

TOUR, sistem okova za rotirajuće prozore, odlikuje se brojnim projektnim mogućnostima koje ga čine jedinstvenim u domeni kvalitete i napretka. TOUR-R omogućava proizvodnju okruglih rotirajućih prozora sa Zračnosti 12 mm. Zahvaljujući širokom asortimanu spojnica i prihvatnika, TOUR za četvrtaste rotirajuće prozore je kompatibilan sa svim sistemima proizvodnje, sa tradicionalnim ili duplim brtvama.

TOUR, hardware system for pivot windows, distinguishes for a number of project opportunities that make it unique for quality and advantages. TOUR-R enables to manufacture circular pivot windows with gap 12. Thanks to a wide range of strikers and hinges, TOUR for rectangular pivot windows is compatible with all systems: traditional, with double gaskets or pre-milled ones.



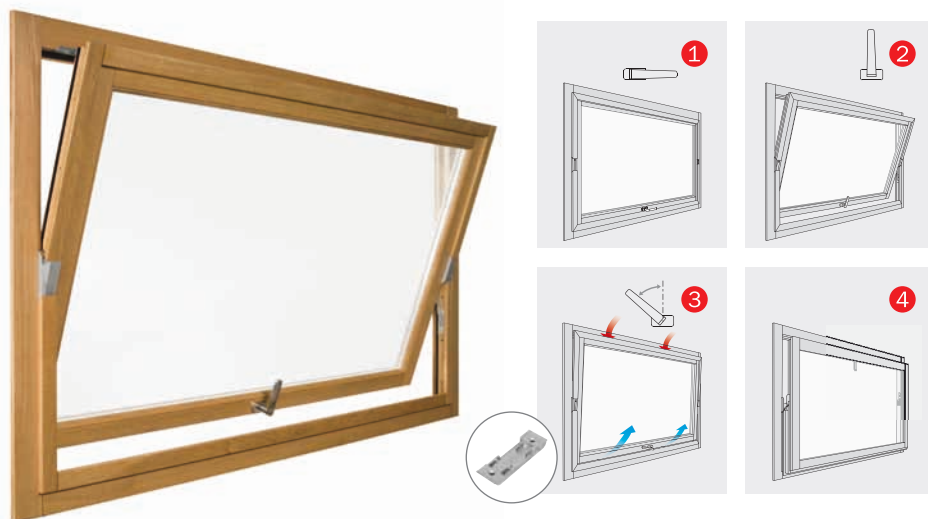

TOUR

CASCADING

- Široki asortiman prihvatnika omogućuje kompatibilnost sa svim sistemima gradnje, tradicionalnim ili duplim brtvama.
 - Zatvorena pozicija sa horizontalnom ručicom. ①
 - Otvorena pozicija sa vertikalnom ručicom. ②
 - Pozicija za zatvaranje na prihvatniku ostaje potpuno slobodna kada se koristi ručica i položaj na prihvatniku za mikroventilaciju (50° pozicija ručice). ③
 - Prozor se rotira za 180° čime je omogućeno lako čišćenje vanjskog stakla. ④
- Wide range of strikers allows compatibility with all building systems, traditional, with double gasket or pre-milled ones.
 - Closing position with horizontal handle. ①
 - Opening position with vertical handle. ②
 - The closing strikers leave complete freedom when choosing the handle and ensure a wider opening for really effective microventilation (50° handle positioning). ③
 - The window rotates of 180° making the outside glass easier to clean. ④

Tri modela spojnice za različite preklope su dostupne za:

- 30 mm preklop, 200 kg ukupne nosivosti;
- 35 mm preklop, 200 kg ukupne nosivosti;
- 40 mm preklop, 300 kg ukupne nosivosti.

Three models of friction hinges are available:

- 30 mm rebate, 200 kg loading capacity;
- 35 mm rebate, 200 kg loading capacity;
- 40 mm rebate, 300 kg loading capacity.



TOUR-R

CASCADING

- Spojnica koja se primjenjuje je nasadna i nezavisna od od transmisije pokreta okova, frezanje krila i okvira nije potrebno. Omogućuje proizvodnju i sa Zračnosti 12 mm.
 - Zatvorena pozicija sa horizontalnom ručicom. ①
 - Otvorena pozicija sa vertikalnom ručicom. ②
 - Prozor se rotira za 180° čime je omogućeno lako čišćenje vanjskog stakla. ③
- Independently from the transmission of the hardware, Tour-R avoids the milling on sash and frame with a surface mounted hinge. Round pivot windows even in gap 12.
 - Closing position with horizontal handle. ①
 - Opening position with vertical handle. ②
 - The window rotates of 180° making the outside glass easier to clean. ③

ZAVRŠNE OBRADJE / FINISHES



21

94

50

- 21. Silver / Silver
- 50. Mesing sjajno / Brass plated
- 94. Smedja / Brown



KLIZNI SISTEMI SLIDING SYSTEMS

Najbolje rješenje za pokretanje velikih i teških krila. Postoje dvije vrste sistema: Podizno klizni koji ima klizni momenat sa otvaranjem i zatvaranjem krila i komplanarni sistem Galileo koji ima kombinaciju kliznog momenta i otvaranje krila na otklop koje nam omogućava bolje provjetravanje prostorije.

The best solution in order to move great and heavy sashes. There are two types of products: Lift & Slide with a sliding movement for opening and closing of the doors and the coplanar system Galileo that combines a sliding movement with a tilt opening system for a better and safer ventilation of the room.

MAKSIMALNE SVOJSTVA MAXIMUM PERFORMANCES



PROPUŠTANJE VODE
WATER TIGHTNESS
do / up to = 9A



PROPUŠTANJE ZRAKA
AIR PERMEABILITY
do / up to = 4



OPTEREĆENJE VJETRA
WIND LOAD
do / up to = C3/A4



OTPORNOST NA UDARE
IMPACT RESISTANCE
do / up to = 5



SMANJENJE BUKE
NOISE ABATEMENT
do / up to = 41 dB
(sa staklom / with glass 43 dB)



TOPLOTNO PROPUŠTANJE
HEAT TRANSMITTANCE
do / up to = 0,69 W/m²K
(sa staklom / with glass 0,5 W/m²K)





AGB ZNA KAKO

AGB je temeljnim istraživanjem, izvršenim tokom dugog vremenskog perioda došao da novih spoznaja i razvoja novih komponenti sposobnih da uveliko poboljšaju svojstva prozora i vrata. Te informacije i spoznaje se prenose proizvođačima prozora i vrata.



BRTVE (TOPLO SPAJANE)

Brtve, pozicionirane sa vanjske strane pokretnog krila su važan faktor u podizanju performansi prozora i vrata. Vanjska brtva ima specijalnu formu i mogućnost kvalitetnog brtvljenja krila preko doljnog praga.



GORNJI BRTVENI PROFIL

Ovo je inovativni izolacijski sistem koji se sastoji od profila naslonjenog na specijalno izrađen profil okvira. Na ovaj način krilo i okvir su spojeni preko ovog profila, koji na sebi ima pjenastu gumu.



UKOPAVAJUĆA GORNJA VODILICA

Kompatibilno za sve AGB sisteme. Ukopavajuća gornja vodilica je potpuno skrivena u okviru i garantira glatko klizanje.



UNI-V PROFIL ZA CENTRALNI SPOJ

Široka radna tolerancija omogućena je sa centralnim spojem Uni-V, koji garantira deklarirane svojstva, čak i nakon prirodne deformacije drva. Ovaj revolucionarni profil izbjegava svaki kontakt između krila i okvira. Pokret otvaranja je lagan i tih.



SVE SA ISTIM ALATOM, KAO I RANIJE!
USING THE MILLING CUTTER YOU ALWAYS USE!

AGB KNOW-HOW

AGB's in-depth research, conducted over a long period of time, has led to the development of new components capable of enhancing the performance ratings of windows and doors. This know-how is transmitted to suppliers of windows and doors.

GASKETS (HEAT-SEALED)

The gaskets, positioned on the perimeter of the moving sash are a vitally important factor in raising the performance ratings of windows and doors. The outer gasket, with its special form, enables sealing of the sash with the threshold.

TOP SEALING PROFILE

This is an innovative insulation system. It consists in a profile running along the top rail of the sash and resting on the listel. The sash and frame are therefore sealed thanks to this profile, featuring closed cells foam rubber.

EMBEDDED TOP GUIDE

It is applicable to every AGB system. The embedded top guide is completely concealed in the frame and guarantees a smooth sliding thanks to the caps provided with the glider.

UNI-V CENTRAL LOCKING PROFILE

The wide working tolerances, allowed by the central point Uni-V, guarantee the declared performances even with the natural deformation of wood. The revolutionary central locking profile avoids every contact between the sash and the frame. The opening movement becomes fluid and silent.



Patentirani proizvod / Patent pending

68-78-92 mm + Uni-V



ŽIVOT BEZ GRANICA

Manje vidljiv okvir, više mjesta za pogled. Sa AGB performansama kvalitete. Imago je inovativni sistem okova za podizno-klizne sisteme od drva, sa debljinom okvira manjim od 2 cm. Imago garantira termo izolaciju, otpornost atmosferskim utjecajima i protuprovalnu sigurnost zahvaljujući integriranom Climatech pragu, posebnoj ponudi inovativnog okova i Poseidon sigurnosnoj bravi.

LIVE OUTSIDE THE BOX

Less visible frame, more space to the image. With the quality of the performances by AGB. Imago is the innovative hardware system which allows to realize the Lift & Slide for wood with a frame depth less than 2 cm. Imago guarantees thermal insulation, resistance against atmospheric agents and anti-burglar security thanks to the integration of the Climatech threshold, the dedicated range of innovative accessories and the Poseidon security lock.

DIZAJN / DESIGN (NE)VIDLJIV PROFIL / (IN)VISIBLE PROFILE



SVOJSTVA / PERFORMANCES TERMOIZOLACIJA I SIGURNOST / THERMAL INSULATION AND SECURITY

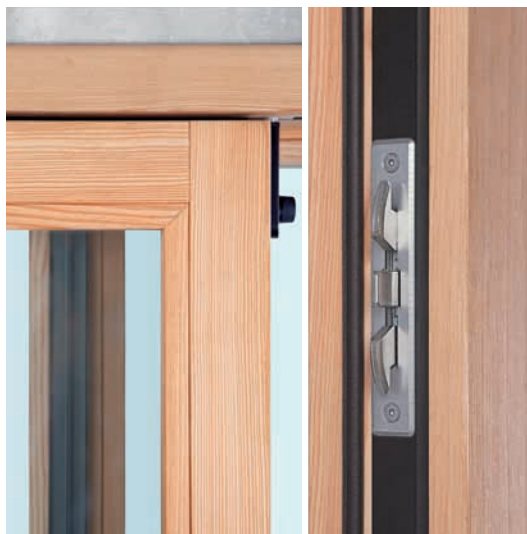

Imago je prvi podizno-klizni sistem od drva izabran od ADI Design Index za takmičenje za Compasso d'Oro. Imago is the first Lift & Slide Door completely in wood selected by the ADI Design Index to compete for the Compasso d'Oro.

- Omogućuje staklu više prostora, soba bez granica: eliminirana je donja prečka fiksnog krila. Staklo i vanjska okolina postaju centar sobe. Tanki aluminijski profil je nosač stakla.
- Napredan dizajn, sa tehnološkim srcem: tanka lajsna okvira izrađena je kao maska, koja pokriva profil sa brtvom.
- Leaving space to the glass, a room without bounds: the lower transom of the fixed sash has been eliminated. The glass and the external environment become the center of the room. A thin aluminium profile creates the glass seat.
- Minimal design, with a technological heart: the thin transom of the frame contains the top sealing profile; no carving is visible.



- Uni-V centralni profil za završavanje: omogućava veću toleranciju u radu, garantira deklarirana svojstva, čak i radi prirodne deformacije drva. Ovaj revolucionarni profil izbjegava svaki kontakt između krila i okvira. Pokret otvaranja je lagan i tih.
- Brava za maksimalnu sigurnost: inovativna Poseidon brava sa dvije kuke i centralnim jezičkom nudi protuprovalni nivo sigurnosti kao nikada do sada.
- Uni-V central locking profile: the wide working tolerances, allowed by the central point Uni-V, guarantee the declared performances even with the natural deformation of wood. The revolutionary central locking profile avoids every contact between the sash and the frame. The opening movement becomes fluid and silent.
- Maximum security lock: the innovative Poseidon lock with two opposite facing hooks and a central bolt offer anti-burglar security levels never known before.

68-78/80-92 mm Uni-V + Easy



DRUGIM RIJEČIMA, ODLIČNO

Novi Climatech projekt je rezultat detaljne studije i aktivnosti testiranja sa terena, omogućava standarde koji su nekada bili potpuno van dosega Podizno- Kliznih vrata i prozora. Vrlo visoke ocjene termičkih svojstava. Dostupan okov za tri varijante (68, 78/80 i 92 mm).

IN OTHER WORDS, EXCELLENCE

The new Climatech project is the outcome of in-depth study and field-testing activities, enabling standards which were once totally beyond the reach of Lift & Slide doors and windows. Very high thermal performance ratings. Accessories for the three types (68, 78/80 and 92 mm).

- Climatech fiberglass doljnji prag: novi kompozitni materijal koji osigurava optimalnu čvrstoću i odličnu termoizolaciju. Završna obrada garantira optimalnu otpornost na grebanje.
- Climatech fiberglass threshold: this new composite-material ensures optimal strength and excellent heat insulation. The finish guarantees optimal scratch resistance.



- Uni-V centralni profil: linearni i minimalistički dizajn. Uni-V je ekstremno elegantan zahvaljujući kapičama za vijke. Kombinira estetske vrijednosti i protuprovalnu funkciju sa lakom montažom. Uni-V komponente skrivene su iza dvije drvene lajsne koje povećavaju termička svojstva i dizajn.
- Uni-V central point: linear and minimal design. Uni-V is extremely elegant thanks to the covers for the fastening screws. It combines aesthetic values and anti-burglar functionalities for an easy installation. Uni-V components are concealed between two wooden listels that increase thermal performances and design.
- Easy centralni profil: dizajniran da osigura glatko klizanje krila. Izrađen je od drvenih lajsni u kombinaciji sa brtvama i četkicom. Centralni profil Easy omogućava da dostignemo visoka svojstva.
- Easy central point: designed to ensure a smooth sliding! It is made of wooden listels with retaining gasket and brush. The central point Easy is able to reach high performances.



Drvo-Aluminij / Wood-Aluminium
Uni-V + Easy
HS Zero + Uni-V



SVOJSTVA & STIL

Climatech se ponavlja sa svojstvima u verziji Drvo-Aluminij fuzijom dizajna i funkcionalnosti. Inovativni centralni profil Uni-V i Easy i dekompresiona zona na strani brave pravi nepropusnu barijeru protiv atmosferskih utjecaja, održavajući visoku estetsku vrijednost vrata. Pogodan za većinu Drvo-Aluminijskih profila.

PERFORMANCES & STYLE

Climatech repeats the performances on the Wood- Aluminium version, fusion of design and functionality. The innovative central points Uni-V and Easy and the decompression chamber on the lock side make an efficient barrier against atmospheric agents, maintaining the high aesthetic value of the door. Suitable with the more widespread Wood-Aluminium profiles.

Alunova, Batiment - Twin System, Europrofili, Gutmann, Torresan Profili, Uniform

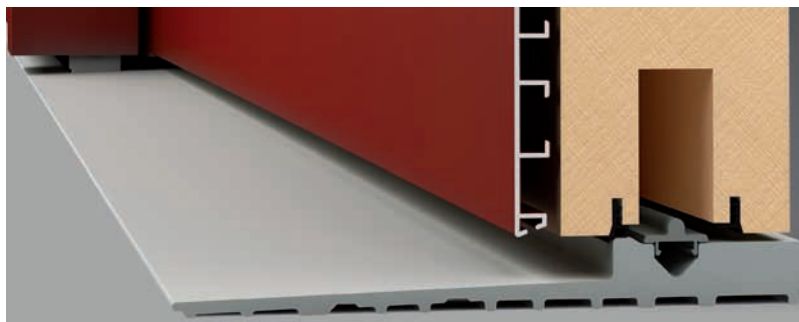

- Climatech fiberglass doljni prag: novi kompozitni materijal koji osigurava optimalnu čvrstoću i odličnu termoizolaciju. Završna obrada garantira visoku otpornost na grebanje.
- Climatech fiberglass threshold: this new composite material ensures optimal strength and excellent heat insulation. The finish ensures optimal scratch resistance.



- Novi Uni-V centralni profil nudi veliku toleranciju prilikom izrade, kompenzira prirodne deformacije drva i pomaže pri uklanjanju uobičajenih post prodajnih problema Podizno-kliznih sistema. Zahvaljujući ovom revolucionarnom profilu, izbjegava se svaki kontakt između krila i okvira. Rezultat je lagan i tih pokret otvaranja.



- The new Uni-V central point offers wide milling tolerances, compensates for the natural deformation of wood and removes the after-sales works on site linked to the Lift & Slide disease. Thanks to this revolutionary central point, there is no contact between the sash and the frame. The result is a fluid and silent opening movement.



- Easy centralni profil: izrađen je od drvenih lajsni, zahvaljujući kombinaciji brtve i četkice, osigurava visoke standarde izolacije i omogućava lijep dizajn vrata.
- Easy central point: made with wooden listels, thanks to the retaining gasket and the brush, reaches high standards in insulation, maintaining the nice design of the door.



- Spoj na strani brave: četkica ugrađena u aluminijski profil kreira dekompresijsku zonu na spoju na strani brave, osigurava prvu prepreku protiv vode, zraka i hladnoće.
- Lock side point: the brush applied on the aluminium profile creates a decompression chamber on the outside of the side point, giving the first barrier against water, air and cold.

INTERMEDIATE INTERMEDIATE

CASCADING

68 mm + Uni-V + Easy



SVOJSTVA & CIJENA

Optimalni rezultati Podizno-kliznih vrata postignuti su sa aluminijским pragom sa termo prekidom, niskom gornjom šinom i centralnim profilom sa Protuprovalnim komponentama. Zahvaljujući jednostavnom ali vrlo važnom priboru, postignuto je da prozori i vrata imaju optimalni nivo otpora, konkurentne cijene i visoki nivo kvalitete.

PERFORMANCES & PRICES

Optimal results for Lift & Slide doors featuring aluminium thresholds with thermal brake, reduced top guide and central point with anti-burglar component. Thanks to simple but important accessories, it takes windows and doors to optimal resistance levels. Competitive prices and top performance ratings.



BASIC BASIC

CASCADING

68 mm + Uni-V 68 mm
78/80-92 mm + Uni-V 78/80-92 mm



ZGODAN & PRAKTIČAN

Odlična svojstva zagwarantirana su za Podizno-klizna vrata sa niskom šinom, niskom gornjom šinom i centralnim profilom od drvenih lajsni. Čak i najjeftinija tradicionalna Podizno-Klizna vrata omogućavaju svojstva koje zadovoljavaju mnoge situacije. Omogućava optimizaciju prozora i vrata i ispunjava zahtjeve kupca za niskom šinom kao estetskog efekta.

GOOD-LOOKING & PRACTICAL

Excellent performances are guaranteed for these Lift & Slide doors with low tracks, reduced top guide and central point with wooden strip. Even the cheapest and most traditional Lift & Slide doors provide performances which enable their use in a broad range of situations. It is indicated when windows and door accessibility must be optimized or when the customer requires a low track for aesthetic effect.



PODIZNO-KLIZNO SKRIVENI L&S VANISHING

CASCADING

57

68 mm + Uni-V + Easy

Dierre, Eclisse, Ermetika, Krona, Metalmeccanica Umbra, Scigno



REZERVIRANO RJEŠENJE

Projekt koji je izgledalo nemoguće certificirati protiv atmosferskih utjecaja, postao je stvarnost. Visoka svojstva na otpornost na vodu, zrak i termiku, kompatibilan je sa svim značajnim protokolima koji se bave energetsom efikasnosti objekata.

THE RESERVED SOLUTION

The project that seemed to be impossible to certificate against atmospheric agents became reality. High performances on waterproof, airtight and heat transmittance rate, compatible with all severe protocols for energy efficient buildings.



PREDNOSTI AGB
PROIZVODA ZA PVC
PODIZNO - KLIZNE SISTEME

ADVANTAGES OF THE AGB
RANGE FOR PVC LIFT & SLIDE



Nosivost do 400 kg
Load capacity
up to 400 kg



Niska šina prilagođena
za sve profile
Customized low threshold for
all the profiles



Certificirano na zrak,
vodu i vjetar
Certified solutions against
air, water and wind



Odlična termička
svojstva
Excellent thermal
performances



NAMJENSKI I CERTIFICIRANI PRAGOVI ZA SVE PROFILE

Dizajn i okov za PVC Podizno - Klizno, AGB je izradio na osnovu svoga znanja koji je postignut nakon puno godina testiranja u unutarjem R&T laboratoriju AGBLab i sa akreditiranim jedinicama. Ovo znanje omogućava tvrtki da prepozna potrebe stolara koji koriste niski prag u razvoju odgovarajućih rješenja.

DEDICATED AND CERTIFIED THRESHOLDS FOR EVERY PROFILE

To design the accessories for PVC Lift & Slide, AGB started from its know-how, reached after many years of tests at the internal R&D laboratory AGBLab and accredited units. This knowledge allows the company to identify the joiner needs developing appropriate solutions using the low threshold.

SOLUCIJE ZATVARANJA ZA KRILA DO 400 KG

- Podloška kompenzator omogućuje nam kompatibilnost sa svim PVC profilima. Sistem fiksiranja na klip osigurava brzu i laganu instalaciju. ①
- Prag Climatech nudi minimalistički dizajn i osigurava nevjerovatne termičke performanse zahvaljujući materijalu od ojačanih staklenih vlakana. ②
- Nova podloška kompenzator za PVC, sa komorama za visoki prag, osigurava nam performanse sa termo prekidom. ③
- Pribor za brtvljenje dizajniran je zahvaljujući znanju stečenom tijekom testiranja u AGB laboratoriji. ④

CLOSING SOLUTIONS FOR 400 KG

- The compensator shims allow the compatibility with all the PVC profiles. The fastening system with clip allows an easy and rapid installation. ①
- The Climatech threshold offers a minimal design and ensures incredible thermal performances thanks to its innovative fibreglass-reinforced composite material. ②
- New PVC compensator shim with chambers for high threshold ensures high thermal cut performances. ③
- The sealing accessories have been designed thanks to the know-know achieved during the tests in AGBLab. ④

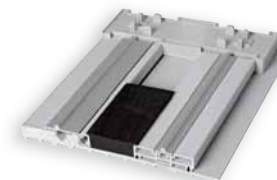
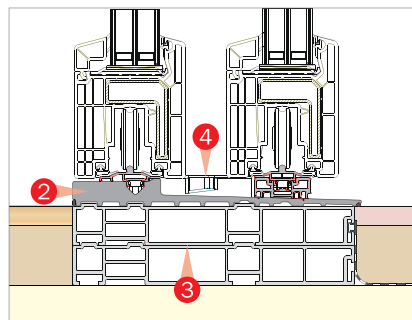
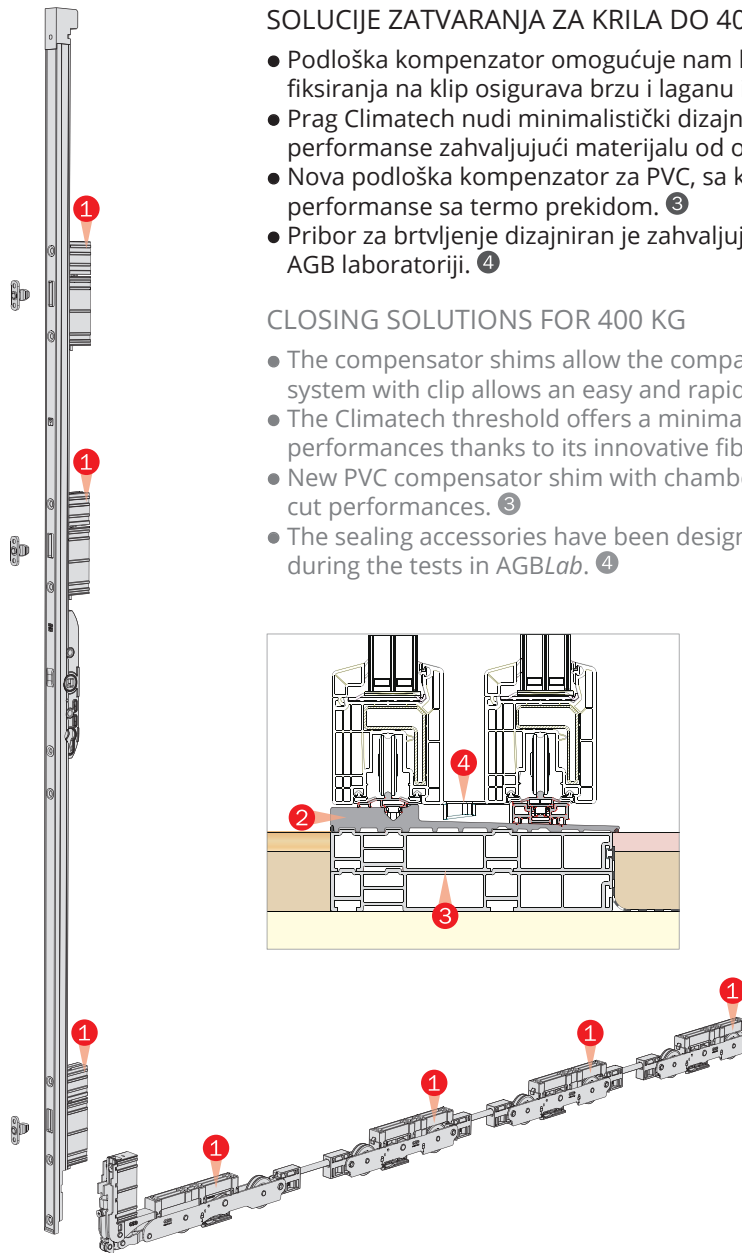



Pribor za komplanarni klizni sistem Galileo sa automatskim, poluautomatskim ili manualnim pokretom. Pogodan je za prostore gdje se ne mogu širom otvoriti vrata za provjetranje sobe. Dostupan je za drvene i PVC sisteme.

Accessories for coplanar sliding system Galileo with automatic, semiautomatic and manual movement. Suitable for places where you can't completely open the sash to air the room. Available for systems in wood and PVC.

GALILEO



GALILEO SA
polu-automatsko / semi-automatic



GALILEO CM
manualno / manual command





OKOV ZA GRILJE I ŠKURE HARDWARE FOR SHUTTERS

Jedan cijeli asortiman proizvoda proučen je da bi zadovoljio sve zahtjeve i vrste sistema. ABACO proizvodi proširuju i kompletan katalog čine bogatijim, i zadovoljavaju svako građevinsko rješenje.

A whole product range properly designed in order to satisfy all the requirements and shutter types.

The ABACO products broaden and make a complete catalogue more precious, satisfying any building solution.





RUČKICE I POGONSKE ŠIPKE ESPAGNOLETTES AND DRIVE RODS

- Pribor za zatvaranje svih tipova grilja i škura (jedno krilo, dva krila, balkonsko krilo). Modeli ručkica: velika, mala, srednja, ravna i ručkica na klik.
- Closing accessories for any type of shutters (one and two sashes, door shutters). Espagnolette models: large, small, reduced, flat and snap-lock type.

NIVO 2 PROTUPROVALNOSTI U
SKLADU SA EN 1627÷30
2ND ANTI-BURGLAR CLASS ACCORDING
TO EN 1627÷30



Brava certificirana
u 2. klasi otpornosti
po EN 1627÷30
standardu.

Lock certified on
2nd resistance class
according to EN
1627÷30 regulations.

ARIETE - Multipoint brava za grilje i škure / Multipoint lock for shutters

- Bez ručkice: ključ pokreće jezičak i zasune.
- BlackTech završna obrada pruža izuzetnu zaštitu od korozije.
- Smanjene dimenzije.
- Širok asortiman rješenja jednostavnih za montažu.
- No handle: key locks bolt and shoot bolts.
- BlackTech finish highly protects from corrosion.
- Reduced dimensions.
- A complete range of easy-to-mount solutions.

Ariete cilindri su također dostupni.
The cylinders Ariete are also available.

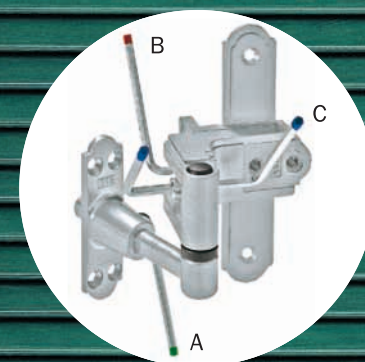
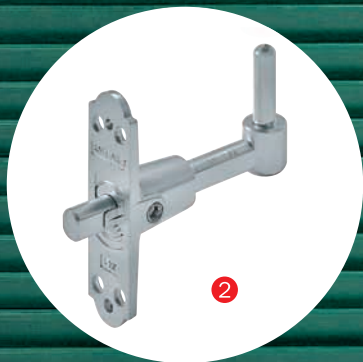
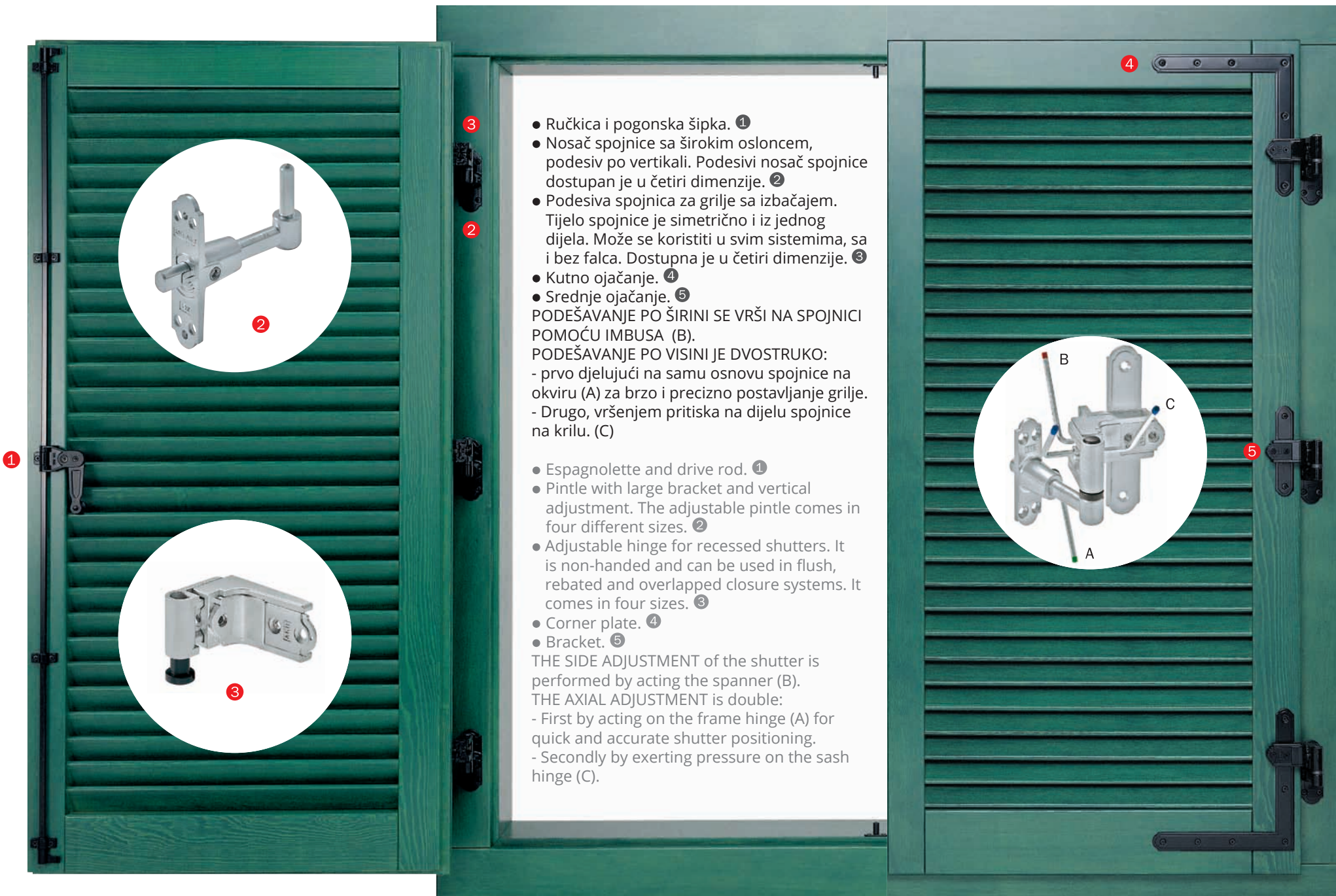

- Ručkica i pogonska šipka. ①
- Nosač spojnice sa širokim osloncem, podesiv po vertikali. Podesivi nosač spojnice dostupan je u četiri dimenzije. ②
- Podesiva spojnica za grilje sa izbačajem. Tijelo spojnice je simetrično i iz jednog dijela. Može se koristiti u svim sistemima, sa i bez falca. Dostupna je u četiri dimenzije. ③
- Kutno ojačanje. ④
- Srednje ojačanje. ⑤

PODEŠAVANJE PO ŠIRINI SE VRŠI NA SPOJNICI POMOĆU IMBUSA (B).

PODEŠAVANJE PO VISINI JE DVOSTRUKO:
 - prvo djelujući na samu osnovu spojnice na okviru (A) za brzo i precizno postavljanje grilje.
 - Drugo, vršenjem pritiska na dijelu spojnice na krilu. (C)

- Espagnolette and drive rod. ①
- Pintle with large bracket and vertical adjustment. The adjustable pintle comes in four different sizes. ②
- Adjustable hinge for recessed shutters. It is non-handed and can be used in flush, rebated and overlapped closure systems. It comes in four sizes. ③
- Corner plate. ④
- Bracket. ⑤

THE SIDE ADJUSTMENT of the shutter is performed by acting the spanner (B).

THE AXIAL ADJUSTMENT is double:

- First by acting on the frame hinge (A) for quick and accurate shutter positioning.
- Secondly by exerting pressure on the sash hinge (C).

POWERAGE

ZAVRŠNA OBRADA SA VISOKOM ZAŠTITOM HI-PROTECTION FINISH



ISTRAŽIVANJE

Nakon suradnje s istraživačkim institutima univerziteta i razvojnom tehnologijom jednog od najvećih proizvođača boja na svijetu - nova Powerage završna obrada.

SVOJSTVA

Aktivno djelovanje elektrokemijske reakcije na sloj cinka kao zaštite proizvoda.

TOP PROIZVOD MASOVNE PROIZVODNJE

Powerage se primjenjuje u proizvodnji svih proizvoda za grilje u Silver i Crnoj obradi.

RESEARCH

Following collaboration with university research institutes, and with technology developed by one of the major paint producers worldwide - the new Powerage finish.

PERFORMANCE

The research for materials protection done in accredited institutes prove excellent results of resistance against salt spray, humidity and ageing.

TOP PRODUCT MASS-PRODUCED

Powerage goes into mass production for all products for shutters with Silver and Black finish.

TRI SLOJA ZAŠTITE

Završna obrada Powerage plus sloj kateforeze, uz adekvatnu pripremu površine fosforizacijom cinkovom soli, pruža posebnu zaštitu protiv korozije prilikom najagresivnijih atmosferskih utjecaja. Istovremeno, štiti sjaj završne obrade, čak i nakon dužeg izlaganja UV zrakama.

THREE-LAYER COVER

Top performing powder coating, plus cataphoresis finish base with adequate preparation of surface by zinc salts phosphatizing, providing a special barrier against corrosion by the more aggressive atmospheric agents while, at the same time, conserving the brightness of the finish, even after prolonged exposure to UV rays.



Čelik Steel

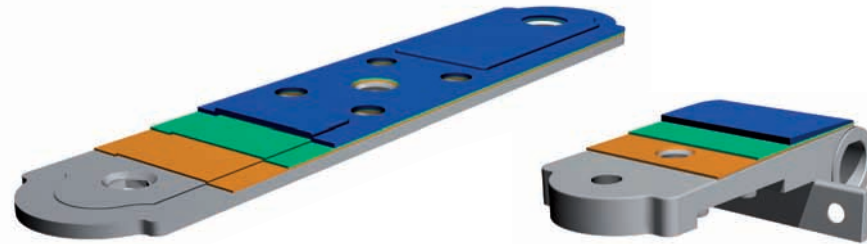

Zamak

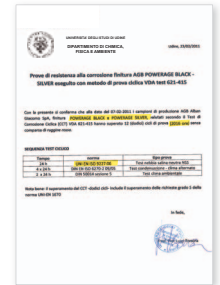
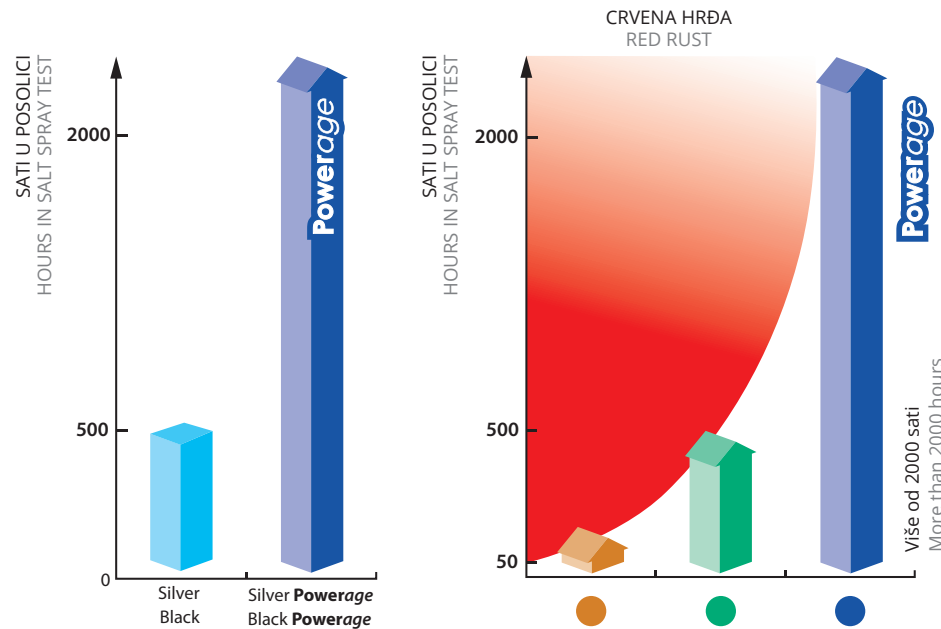

Powerage Crna i Silver: 2016 sati u posolici bez tragova crvene hrđe u skladu sa VDA 621-415.

Powerage Black and Silver: 2016 hours in salt spray test without any red rust spot according to VDA 621-415.

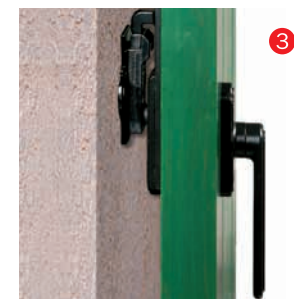
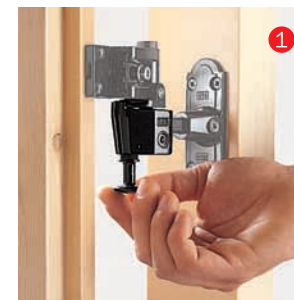

SPOJNICE ZA ZID / MASONRY PINTLES

- Fiksni i pokretni krak sa sistemom za blokiranje. Nosači sa oblim i običnim ležištem.
- Fixed and removable pins with stop dowel. Tapered and ordinary seat.

ZASUNI / BOLTS

- Grilje su puno sigurnije protiv provala. Dostupni u horizontalnim i vertikalnim verzijama za jedno ili dva krila.
- Make the shutters more secure against break-in attempts. Horizontal and vertical versions. They are available for single or double sashes.

ZIDNI DRŽAČI KRILA WALL CATCHES FOR SHUTTERS WITH HANDLE

- Automatski: oslobađanje kočnice vrši se lakim pokretom ruke. ①
- Zidni: blokira krilo u položaju maksimalnog otvaranja, držeći ga pričvršćenog na zidu. ②
- Sa ručicom: idealno rješenje za grilje na balkonskim vratima. Ručica istovremeno omogućuje oslobađanje i privlačenje krila. ③
- Archimede: Podizanjem ručice mehanizam se aktivira i zidni držač ostaje otvoren sve dok krilo ne pređe preko njega i odblokira ga, pritom ga vraća u početni položaj. ④
- Hinge catch: it can be released easily with just one hand. ①
- Wall catch: holds the leaf wide open, securing it to the wall. ②
- Catch with handle: the solution for shutters of balcony doors with breastrail. The through handle allows to release and drag the sash contemporaneously. ③
- Archimede: by lifting the stopping bow this is armed and the wall catch stays open until the sash, passes over it and unblocks it restoring the original position. ④



Navedeni podaci mogu biti neispravni samo u slučaju štamparskih greški ili prilikom eventualnih izmjena od strane proizvođača.
The supplied data and pictures are to be considered valid saving any printing error or modifications introduced by the manufacturer.